



■ Model Name	OLU400P701N1U
■ Model Code	PSOV400701U(N) PSOV400701W(N)

■ Features :

- Flickerless
- Full-protection provided: OCP/OVP/OTP/SCP/OLP
- Wide Vout : 25 ~ 50Vdc
- Compliant with CB, CE, UL safety requirements for LED lighting
- Constant Current Type
- IP 67
- Non Dimming



SOLUM CO., LTD

150, Maeyoung-Ro, Youngtong-Gu, Suwon-Si, Gyeonggi-Do, Republic of Korea 443-743

TEL: +82-1588-0502, www.solu-m.com

■ Electrical specification

No.	Item	Min	Typ	Max	Unit	Remark	
1	Nominal Input Voltage	120	220	277	Vac		
2	Variable Input Voltage	108	-	300	Vac		
3	Maximum Input Current	-	-	0.4	Arms		
4	Nominal Input Frequency	47	50/60	63	Hz		
5	Power Factor (PF)	90	-	-	%	1)	
6	Total Harmonic Distortion (THD)	-	-	20	%	1)	
7	Inrush Current	-	-	60	Arms	Duration 500 μ s , 9) Meets NEMA 410	
8	Electrical Efficiency	84	87	-	%	2)	
9	Turn-on Delay	-	-	0.5	s	@Cold Start, 3)	
10	LED Output Current	665	700	735	mA	@50Vdc Load 2)	
11	LED Output Current Ripple	-	-	70	mA	20MHz Bandwidth, 2)	
12	LED Output Voltage	25	-	50	Vdc		
18	Output Open LED Protection	-	-	59	Vdc	@Vpeak	
19	Output Short Circuit Protection	-	-	-	-	No Damage	
20	Storage Temperature	-40	25	80	°C		
21	Operating Temperature	-40	25	50	°C		
22	Case Temperature (Tc)	-	50	85	°C	Ta = 60°C	
23	Humidity	20	-	85	%		
24	Insulation Resistance	10	-	-	M Ω	500Vdc between Input & Output	
25	Dielectric Withstand Voltage	Input to Output	3.75	-	-	kV	Apply for 1 minute 6)
26		Input to Case	3.75	-	-	kV	
27		Output to Case	0.5	-	-	kV	
28	Surge	Line to Line	6	7	-	kV	4)
29		Line to Ground	8	9	-	kV	4)
30	ESD	Contact Discharge	4	-	-	kV	5)
31		Air Discharge	8	-	-	kV	5)

SOLUM CO., LTD

150, Maeyoung-Ro, Youngtong-Gu, Suwon-Si, Gyeonggi-Do, Republic of Korea 443-743

TEL: +82-1588-0502, www.solu-m.com

Application Notes

- 1) Test Condition: 120/277Vac 50/60Hz Input, Typical LED Load, Ambient Temperature 25°C, Measure at the cable-end
- 2) Test Condition: 220Vac 60Hz Input, LED Max. Load, 30min Aging, Ambient Temperature 25°C
- 3) The interval of turn on/off should be over 1sec.
- 4) Surge Specification above is higher than IEC/EN 61000-4-5 Level 4 (Differential 2kV, Common 4kV)
- 5) The metal case of the LED driver must be connected with F.G
- 6) ESD Specification above meets IEC/EN 61000-4-2 Requirements (Contact Level 2, Air Level 3)
- 7) The metal case of the driver should be grounded.
- 8) Determined by Paragraph 34.1.2, UL1310 or Paragraph 8.4.2, UL8750, EN61347-1, EN61347-2-13
- 9) NEMA 410 peak current requirement

Complied $I^2t(A^2sec)$ @ peak $\leq 2ms$

Table 2
Peak Current Requirements with Pulse Widths ≤ 2 ms

Steady State Current (A)	Peak Current (A) 120 Vac	Pulse Width 120 Vac (ms)	I^2t (A ² sec) 120 Vac	Peak Current (A) 277 Vac	Pulse Width 277 Vac (ms)	I^2t (A ² sec) 277 Vac
0.5	75	0.34	11	77	0.07	11
1	107	0.48	24	131	0.71	27
2	144	0.70	41	205	0.85	76
3	166	0.89	51	258	0.98	111
5	192	1.20	74	320	1.20	205
8	221	1.25	98	370	1.25	274
10	230	1.50	106	430	1.50	370

Safety Standards

Including safety requirements above, the LED driver complies with the following safety standards:

No.	Item	Description
1	IEC/EN 61347-1, IEC/EN 61347-2-13	IEC/EN Safety Standards
2	IEC/EN 55015	Conducted and Radiated Emission Test
3	IEC/EN 61000-3-2	Harmonic current emissions: Class C
4	IEC/EN 61000-3-3	Voltage Fluctuations and Flicker
5	IEC/EN 61000-4-2	Electrostatic Discharge (ESD): Contact Level 2, Air Level 3
6	IEC/EN 61000-4-3	Radio-frequency Electromagnetic Fields
7	IEC/EN 61000-4-4	Electrical Fast Transients (EFT)
8	IEC/EN 61000-4-5	Surges: Level 4
9	IEC/EN 61000-4-6	Injected Currents
10	IEC/EN 61000-4-8	Power Frequency Magnetic Fields
11	IEC/EN 61000-4-11	Voltage Dips and Short Interruptions

SOLUM CO., LTD

150, Maeyoung-Ro, Youngtong-Gu, Suwon-Si, Gyeonggi-Do, Republic of Korea 443-743

TEL: +82-1588-0502, www.solu-m.com

■ Operating window

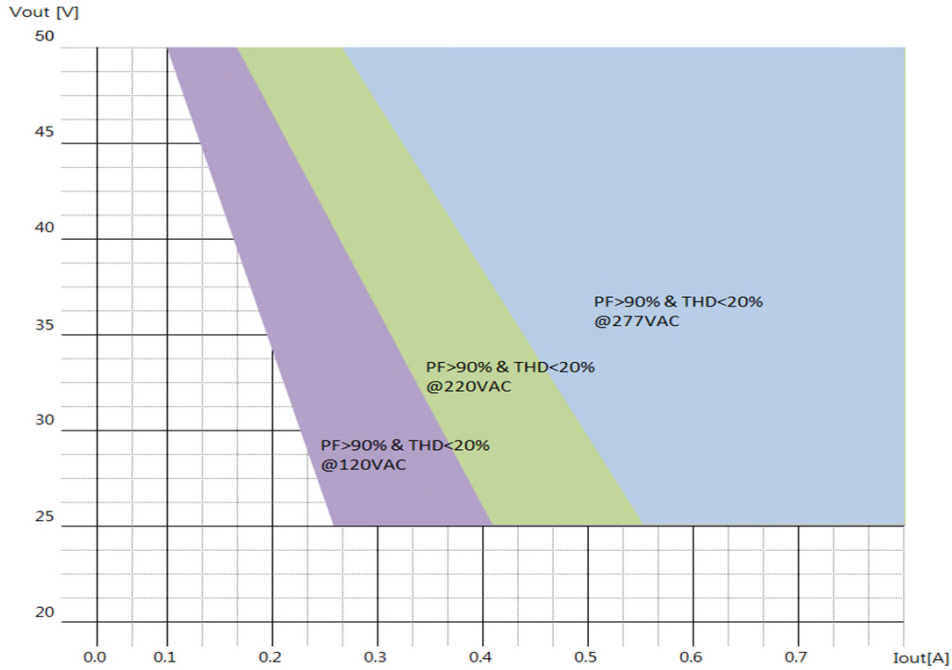

■ Life Time vs Tcase

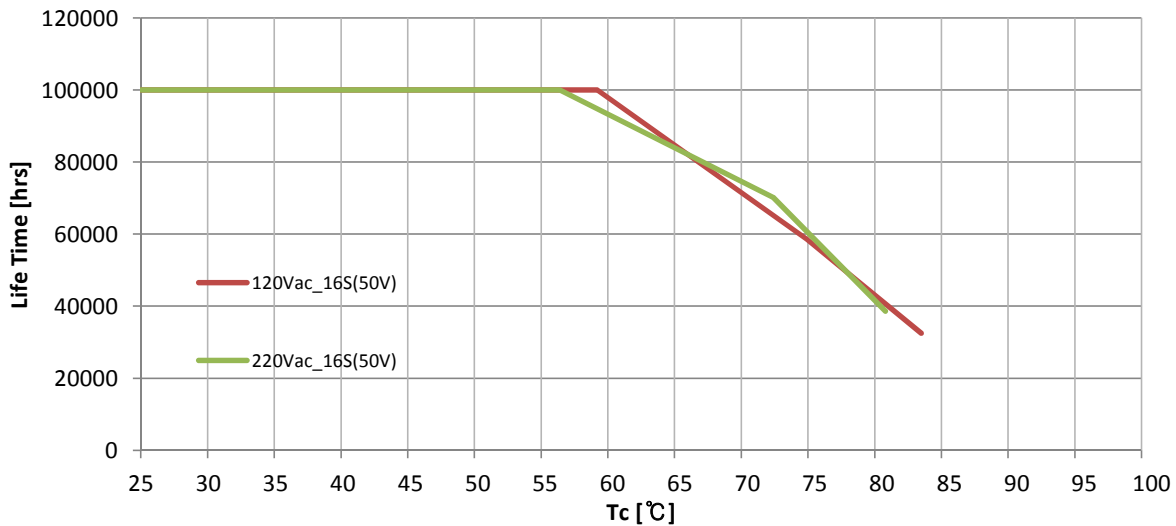

Remark) LED Driver has a rated lifetime of 50,000 hours @ Tc ≤ 70°C

SOLUM CO., LTD

150, Maeyoung-Ro, Youngtong-Gu, Suwon-Si, Gyeonggi-Do, Republic of Korea 443-743

TEL: +82-1588-0502, www.solu-m.com

■ Power Factor(%)

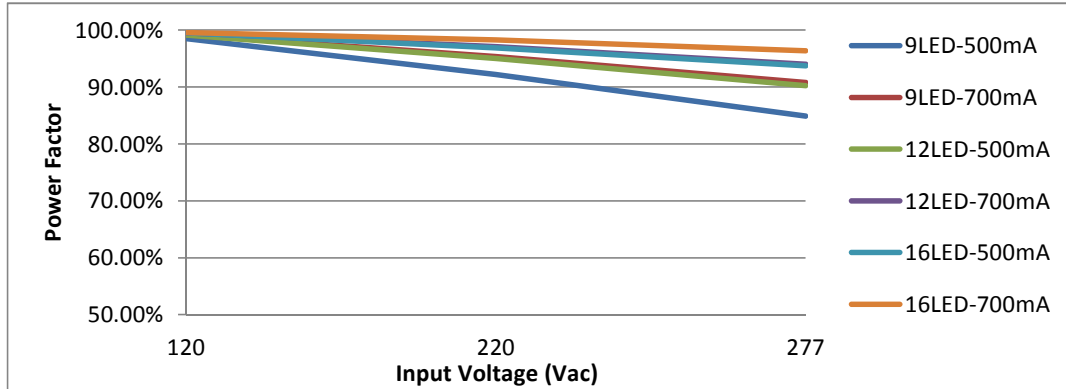

■ THD(%)

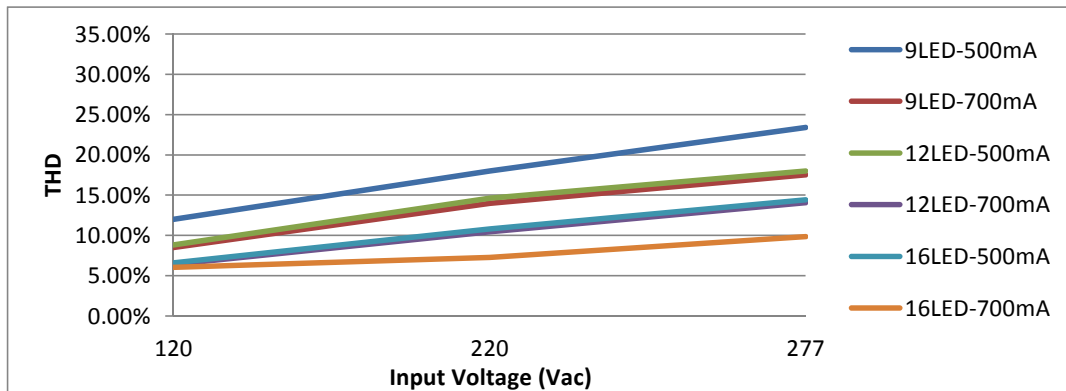

■ Efficiency(%)

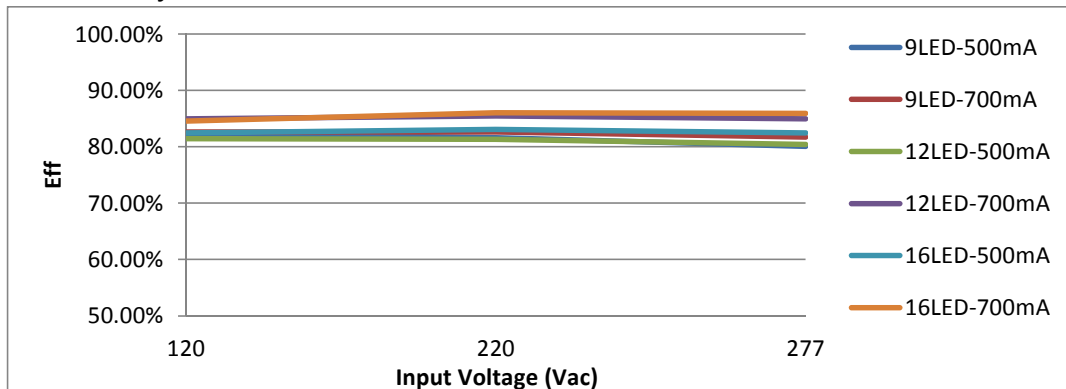

SOLUM CO., LTD

150, Maeyoung-Ro, Youngtong-Gu, Suwon-Si, Gyeonggi-Do, Republic of Korea 443-743

TEL: +82-1588-0502, www.solu-m.com



Flickerless / Power supply

OLU400P701N1U

PSOV400701*(N)

*Currently Measurement Data

■ Output Current(mA)

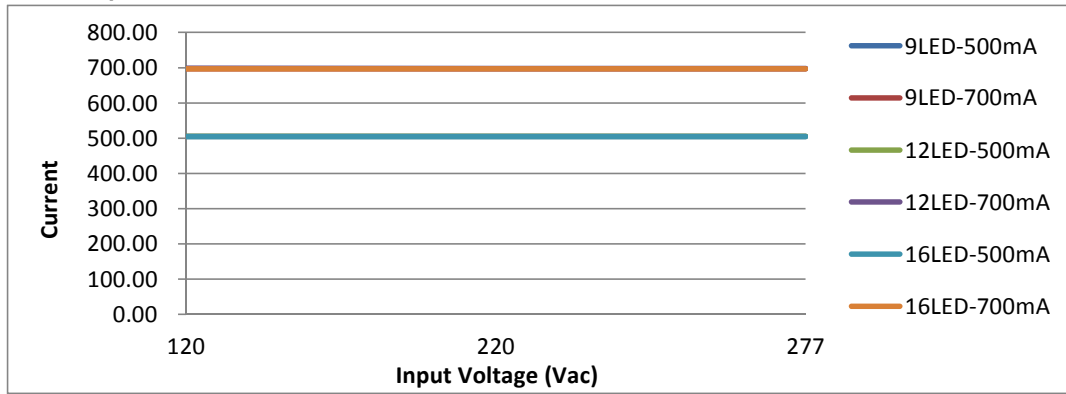

SOLUM CO., LTD

150, Maeyoung-Ro, Youngtong-Gu, Suwon-Si, Gyeonggi-Do, Republic of Korea 443-743

TEL: +82-1588-0502, www.solu-m.com

■ Mechanical Specification

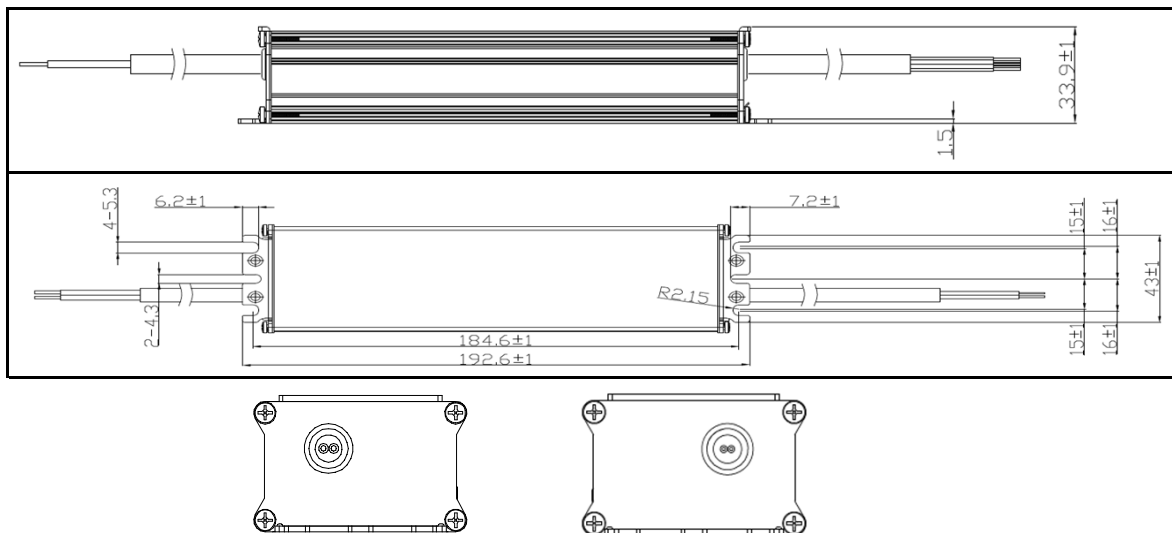
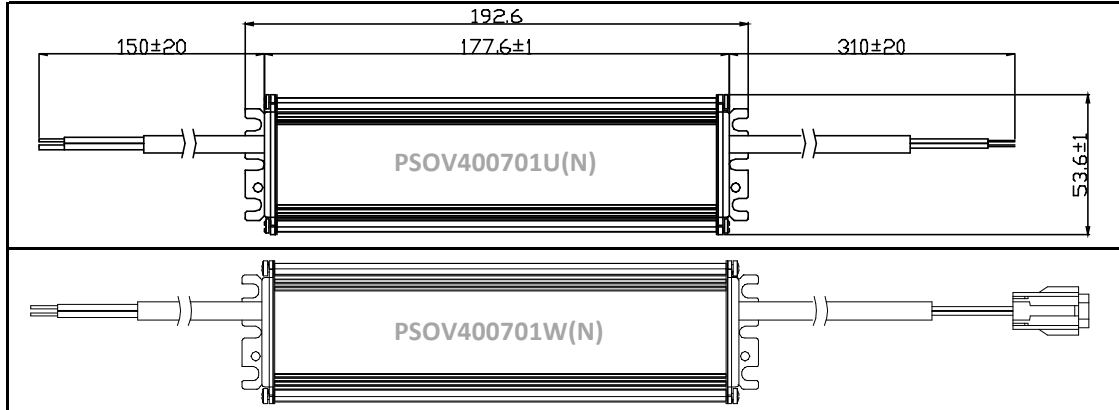

■ Enclosure Size

Unit	Width	Length	Height	Mount Length	Overall Length
mm	53.6	177.6	33.9	185.4	192.6
inch	2.11	6.99	1.33	7.30	7.58

■ Case Material : Aluminium

SOLUM CO., LTD

150, Maeyoung-Ro, Youngtong-Gu, Suwon-Si, Gyeonggi-Do, Republic of Korea 443-743

TEL: +82-1588-0502, www.solu-m.com

■ **Wiring Diagram**



■ **Out connector description**

Code	Logo	Connector (Cable end)	Connector (opposite side)	Remark
PSOV400701U(N)	SOLUM	N.A	N.A	 MG610320(KET)
PSOV400701W(N)		MG610320(KET)	MG640322(KET)	

※ **Caution**









- 1) Before installing LED driver, AC power should be turned off.
After installing LED driver, AC power should be turned on.
- 2) When this LED driver are installed as an independent lamp controlgear, end-customer should protect connecting leads of pri/sec. cable with a certified element.
- 3) Waterproof connector or Junction box can be assembled with output cables for operating in dry/wet/damp or outdoor environment.
- 4) Wires should be less than 1m when installed in final equipment
- 5) Do not detach input and output wires after complete installation.
- 6) The metal enclosure should be grounded in purpose of EMC performance.

SOLUM CO., LTD

150, Maeyoung-Ro, Youngtong-Gu, Suwon-Si, Gyeonggi-Do, Republic of Korea 443-743

TEL: +82-1588-0502, www.solu-m.com

Rating Label Drawing

<p>L LIVE (흑색, Black)</p> <p>N Neutral (백색, White)</p> <p>PRI 정격입력 U_n : 120 - 277V~ 50/60 Hz I_n : Max. 0.4A 0.20A...220Vac,60Hz P_n : 45W λ-역률 : 0.9</p>	<p>SOLUM</p> <p>CAUTION (주의사항) Suitable for dry and damp location Use for LED Module only Do not open the case</p> <p>Hillsite Am Kronberger Hang 8, 65824 Schwalbach Ts. Germany. www.solu-m.com AS : +82-1588-0502 Made in China Dongguan SOLUM Electronics Co., Ltd.</p>	<p>LED CONVERTER 조명기구용 컨버터 (LED 램프용) Constant Current (정전류 방식) ■ tc t_a : -40 - 50°C Flickerless t_c : 85°C</p> <p>IP67</p> <p>Model/모델 : OLU400P701N1U Name/기종 : PSOV400701U(N)</p> <p>SELV    US E480967</p>	<p>SEC 정격출력</p> <p>P_{out} : 35W I_{out} : 0.7A V_{out} : 25 - 50V ≡ V_{OLP} : Max. 59V ≡ (OLP : Open Lamp_무부하)</p> <p>LED LED -  (Blue 형색) LED +  (Red 형색)</p>
<p>L LIVE (흑색, Black)</p> <p>N Neutral (백색, White)</p> <p>PRI 정격입력 U_n : 120 - 277V~ 50/60 Hz I_n : Max. 0.4A 0.20A...220Vac,60Hz P_n : 45W λ-역률 : 0.9</p>	<p>SOLUM</p> <p>CAUTION (주의사항) Suitable for dry and damp location Use for LED Module only Do not open the case</p> <p>Hillsite Am Kronberger Hang 8, 65824 Schwalbach Ts. Germany. www.solu-m.com AS : +82-1588-0502 Made in China Dongguan SOLUM Electronics Co., Ltd.</p>	<p>LED CONVERTER 조명기구용 컨버터 (LED 램프용) Constant Current (정전류 방식) ■ tc t_a : -40 - 50°C Flickerless t_c : 85°C</p> <p>IP67</p> <p>Model/모델 : OLU400P701N1U Name/기종 : PSOV400701W(N)</p> <p>SELV    US E480967</p>	<p>SEC 정격출력</p> <p>P_{out} : 35W I_{out} : 0.7A V_{out} : 25 - 50V ≡ V_{OLP} : Max. 59V ≡ (OLP : Open Lamp_무부하)</p> <p>LED LED -  (Blue 형색) LED +  (Red 형색)</p>

SOLUM CO., LTD

150, Maeyoung-Ro, Youngtong-Gu, Suwon-Si, Gyeonggi-Do, Republic of Korea 443-743

TEL: +82-1588-0502, www.solu-m.com

■ Barcode Label



DATE
BARCODE
LOT NO

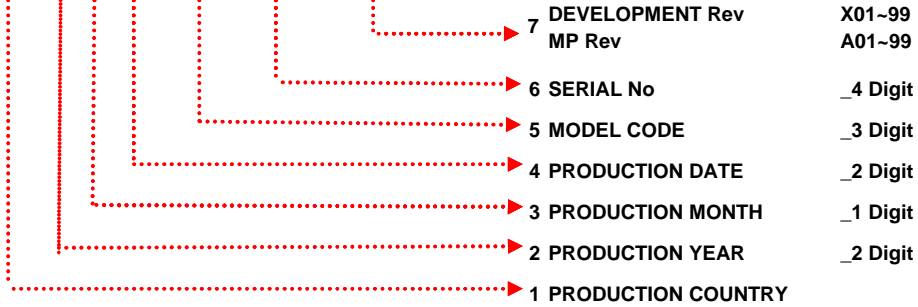

Mean	1.PLANT	2. YEAR	3. MONTH	4. DATE	5. CODE	6. SERIAL	7. Revision No
Digit	2	2	1	2	3	4	
EX.	C1 : DGSM C2 : Solytech K1 : Korea H1 : SOLUM VINA	00~99	1...9,A,B	01~31	PSOV400701U(N) : 393 PSOV400701W(N) : 394	0001.. 9999	X01~99 : DEVELOPMENT A01~99: MP

Material Code	OLU400P701N1U		USER Model Code
ITEM	PSOV400701*(N) REV. A**		SOLUM Model Code
LOT No	*****	MAKER	SOLUM LOT NO & Quantity of Products
Quantity [PCS]	24	SOLUM	
EXP. Date	20**.**.** ~ 20**.**.**		Product Date ~ After 5 years
	 ***** **		USER Barcode

Digit	Year			Month			Date			Factory			Fixed		
	1	2	3	4	5	6	7	8	9	0	1	2	3	4	5
Q	0	1	1	1	1	D	0	0	1						
P→2016						D : SoluM									
Q→2017	01~12月			01~31日			A : Aptech								
R→2018						H : Soumvina									

Digit	Quantity Per BOX									BOX Size	Serial No.				Blank	Vender Code				Blank	Year			Month			Date			Factory			Fixed		
	1	2	3	4	5	6	7	8	9	10	11	12	13	14	15	16	17	18	19	20	21	22	23	24	25	26	27	28	29	30					
Q	0	0	0	0	0	0	0	2	4	B	0	0	1	E	6	0	1					Q	0	1	1	1	D	0	0	1					
										A : Pallet B : BOX	001-999												P→2016 Q→2017 R→2018	01~12月 01~31日			D : SoluM A : Aptech H : Soumvina								

SOLUM CO., LTD

150, Maeyoung-Ro, Youngtong-Gu, Suwon-Si, Gyeonggi-Do, Republic of Korea 443-743

TEL: +82-1588-0502, www.solu-m.com

■ Packing Drawing

1. Out Box

Dimension	540(L) 355(W) 170(H) [mm]
Weight	< 14Kg
Quantity	24EA / 1Box

TRY BODY

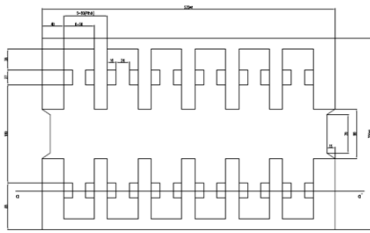

NIL PAD

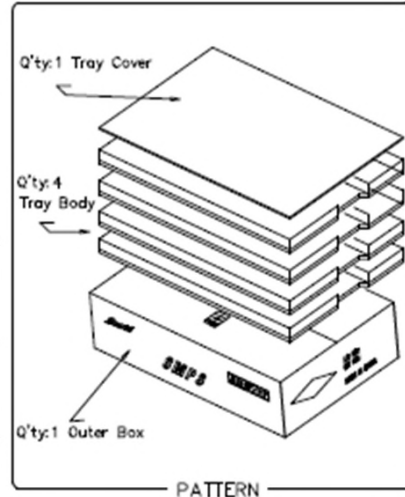
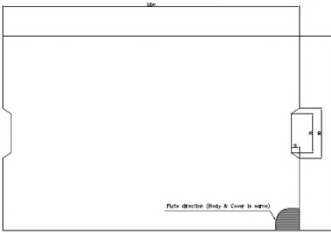

OUT BOX

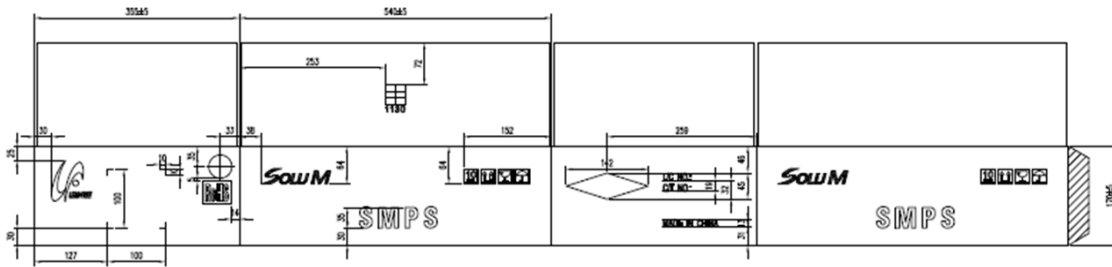

2. Pallet

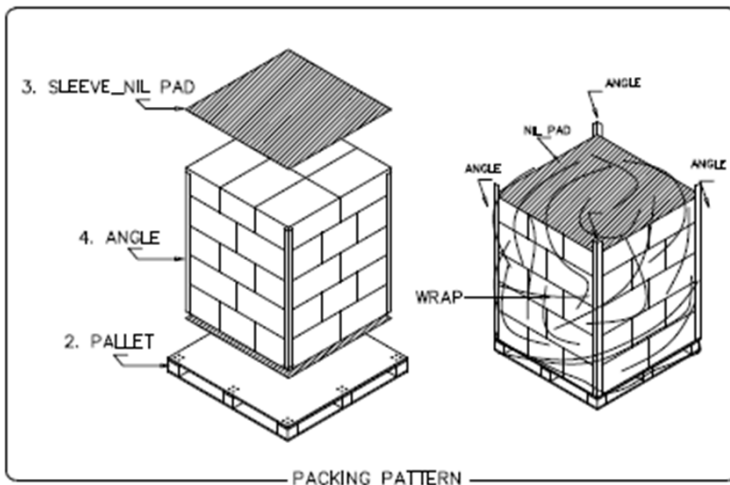

Weight	< 420Kg
Quantity	30BOX / 1Pallet

SOLUM CO., LTD

150, Maeyoung-Ro, Youngtong-Gu, Suwon-Si, Gyeonggi-Do, Republic of Korea 443-743

TEL: +82-1588-0502, www.solu-m.com