

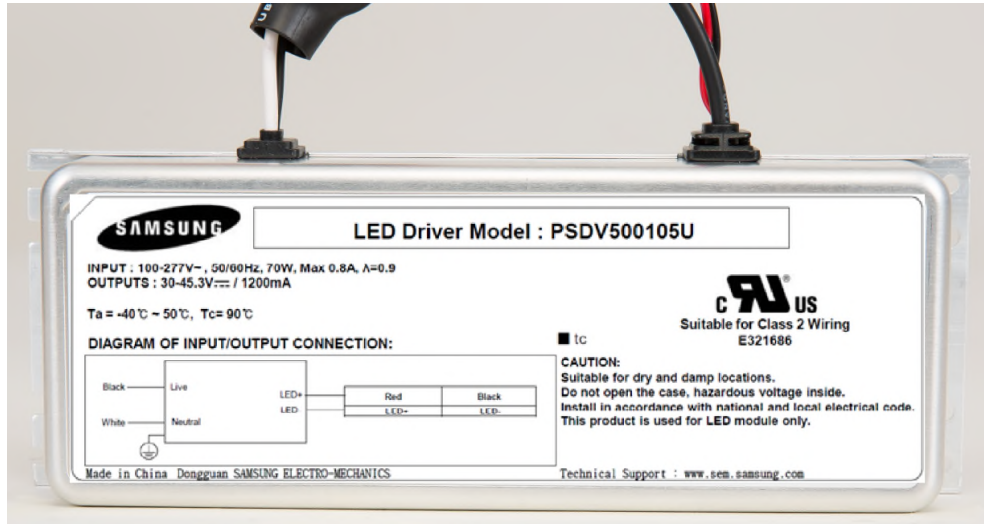

ELECTRO-MECHANICS

50W Single Output LED Driver

PSDV500105U



■ Model Name : PSDV500105U

■ Features :

- Suitable for LED lighting application
- UL8750, UL1310 Class 2
- For use in Dry and Damp Location
- Full-protection provided: OCP/OLP/OTP/SCP
- Non potting product



SAMSUNG ELECTRO-MECHANICS CO., LTD

150, Maeyoung-Ro, Youngtong-Gu, Suwon-Si, Gyeonggi-Do, Republic of Korea 443-743

TEL: +82-31-210-5114, www.samsungsem.co.kr



■ Electrical specification

No.	Item	Min	Typ	Max	Unit	Remark
1	Nominal Input Voltage	100		277	Vac	
2	Wide Input Voltage	90		305	Vac	
3	Maximum Input Current			0.8	Arms	
4	Nominal Input Frequency	50		60	Hz	
5	Wide Input Frequency	47		63	Hz	
6	Power Factor (PF)	0.9				1)
7	Total Harmonic Distortion (THD)			20	%	1)
8	Inrush Current	Meets NEMA 410				@Cold Start, 9)
9	Earth Leakage Current			500	μA	
10	Output Voltage	30	38	45.3	Vdc	
11	Output Current	1,080	1,200	1,320	mA	@30min Aging, 1)
12	Output Peak Current			1,500	mA	1)
13	Output Current Ripple			120	mA	1)
14	LED Output Aging Current Differential			±60	mA	2hr Aging
15	Turn-on Delay			750	ms	2)
16	Electrical Efficiency	86.5			%	3)
17	Output Open LED Protection	-	-	-	Vdc	Auto-recovery
18	Output Short Circuit Protection	-	-	-	-	Auto-recovery
19	Over-temperature Protection	105			°C	Auto-recovery
20	Case Temperature (Tc)			90	°C	
21	Storage Temperature	-30		90	°C	
22	Operating Temperature	-30		50	°C	4)
23	Humidity			90	%	
24	Vibration			3	G	
25	Insulation Resistance	100			MΩ	500Vdc between Input & Output
26	Differential Mode (Line to Line)	-4		4	kV	5)
27	Common Mode (Line to Ground)	-6		6	kV	5) 6)
28	Contact Discharge Test Voltage	-4		4	kV	7)
29	Air Discharge Test Voltage	-8		8	kV	7) 8)
30	Dielectric	Input to Output	1,554		Vac	Apply for 1 minute 10)
31	Withstand	Input to Case	1,554		Vac	
32	Voltage	Output to Case	500		Vdc	

SAMSUNG ELECTRO-MECHANICS CO., LTD

150, Maeyoung-Ro, Youngtong-Gu, Suwon-Si, Gyeonggi-Do, Republic of Korea 443-743

TEL: +82-31-210-5114, www.samsungsem.co.kr

Application Notes

- 1) Test Condition: 100/277Vac 50/60Hz Input, Typical LED Load, Ambient Temperature 25°C
- 2) Test Condition : Input 277Vac 60Hz, Typ. Load @25°C, Cold start
- 3) Efficiency Test Condition: 240Vac Input, 30min. Aging, Typical LED Load, Ambient Temperature 25°C
- 4) Driver may not meet turn-on delay and output ripple current specification under -30°C
- 5) Surge Specification above is higher than IEC/EN 61000-4-5 (Differential 1kV, Common 2kV)
- 6) The metal case of the LED driver must be connected with F.G
- 7) ESD Specification above meets IEC/EN 61000-4-2 Requirements (Contact 4kV, Air 8kV)
- 8) The metal case of the driver should be grounded.
- 9) Input 120Vac, < 107Apeak, < 0.48ms, < 24A2sec
- 10) Determined by Paragraph 34.1.2, UL1310 or Paragraph 8.4.2, UL8750, EN61347-1, EN61347-2-13

Safety Standards

Including safety requirements above, the LED driver complies with the following safety standards:

No.	Item	Description
1	UL8750, UL1310	UL Safety Standards (Class 2, Dry and Damp Location)
2	IEC 61000-3-2	Harmonic current emissions: Class C
3	IEC 61000-3-3	Voltage Fluctuations and Flicker
4	IEC/EN 61000-4-2	Electrostatic Discharge (ESD): Contact 4kV, Air 8kV
5	IEC 61000-4-3	Radio-frequency Electromagnetic Fields
6	IEC 61000-4-4	Electrical Fast Transients (EFT)
7	IEC/EN 61000-4-5	Surges: Differential 1kV, Common 2kV
8	IEC 61000-4-6	Injected Currents
9	IEC 61000-4-8	Power Frequency Magnetic Fields
10	IEC 61000-4-11	Voltage Dips and Short Interruptions

SAMSUNG ELECTRO-MECHANICS CO., LTD

150, Maeyoung-Ro, Youngtong-Gu, Suwon-Si, Gyeonggi-Do, Republic of Korea 443-743

TEL: +82-31-210-5114, www.samsungsem.co.kr

■ Life Time vs Tcase

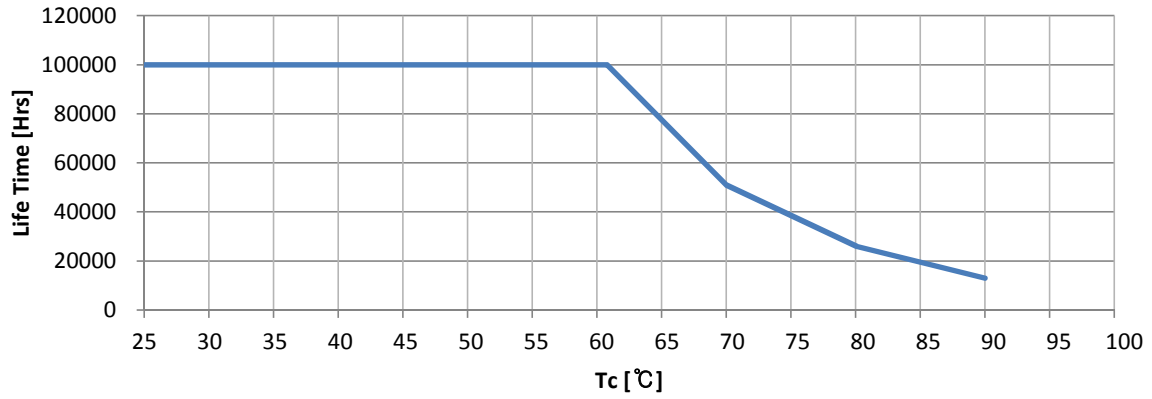

Remark) LED Driver has a rated lifetime of 50,000 hours @ Tc ≤ 70°C

■ Efficiency(%)

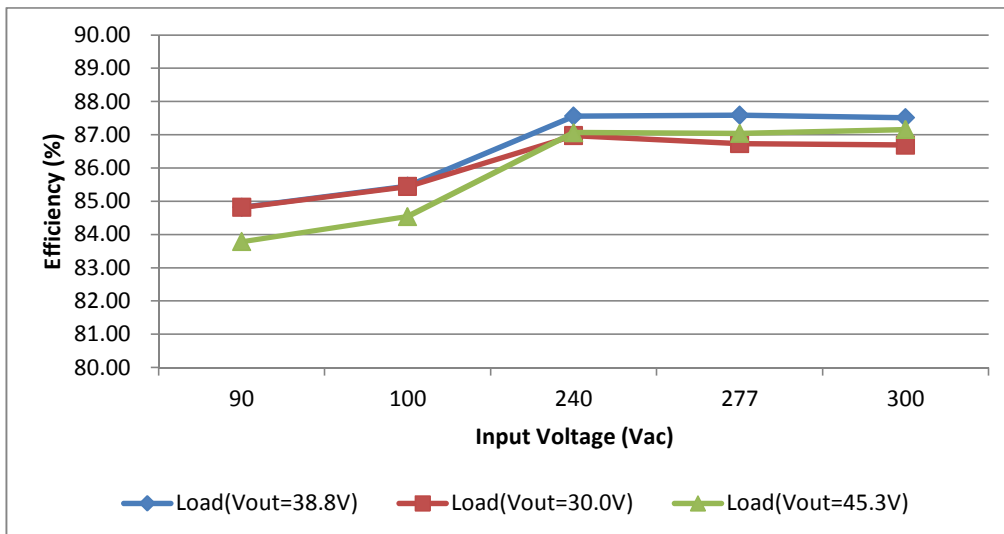

SAMSUNG ELECTRO-MECHANICS CO., LTD

150, Maeyoung-Ro, Youngtong-Gu, Suwon-Si, Gyeonggi-Do, Republic of Korea 443-743

TEL: +82-31-210-5114, www.samsungsem.co.kr

■ Power Factor

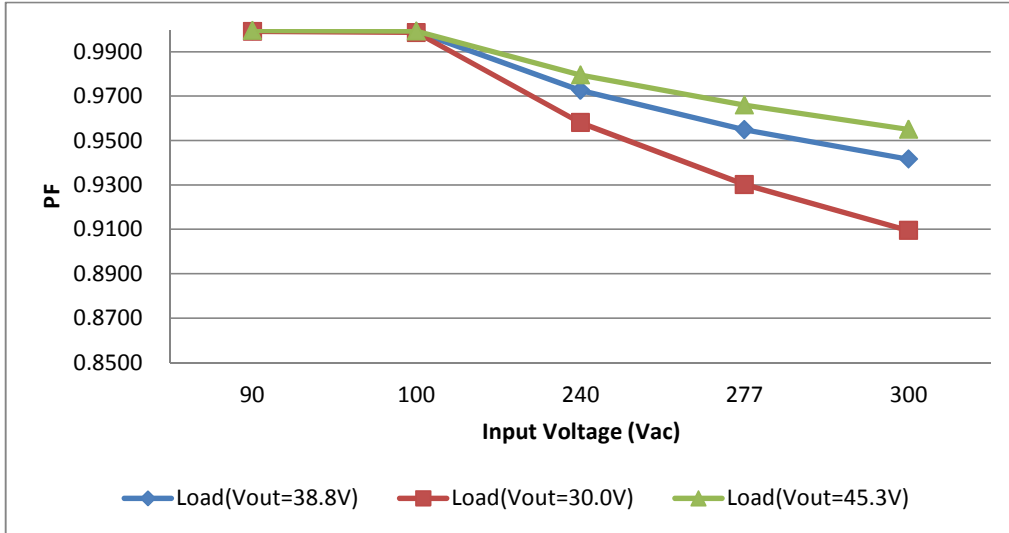

■ THD(%)

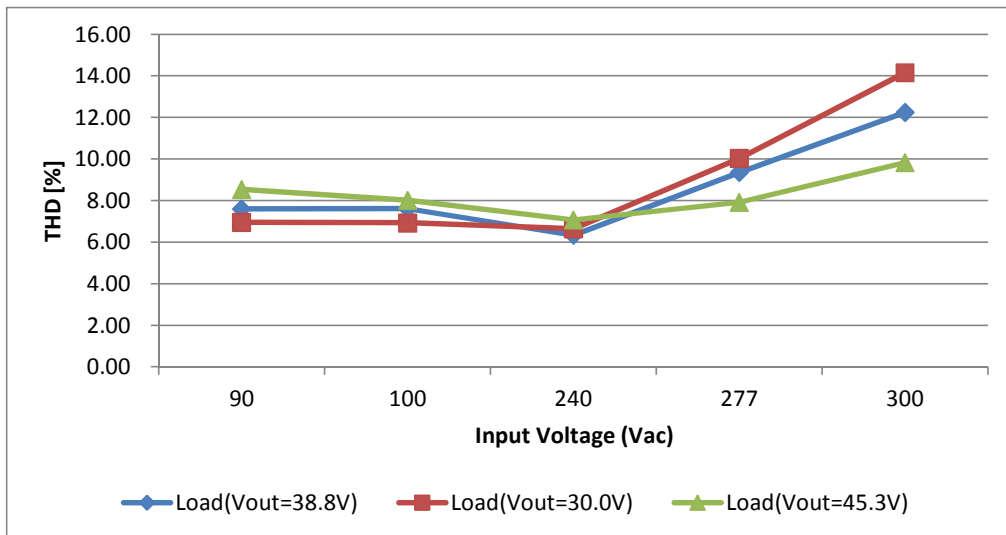

SAMSUNG ELECTRO-MECHANICS CO., LTD

150, Maeyoung-Ro, Youngtong-Gu, Suwon-Si, Gyeonggi-Do, Republic of Korea 443-743

TEL: +82-31-210-5114, www.samsungsem.co.kr

■ Mechanical Specification

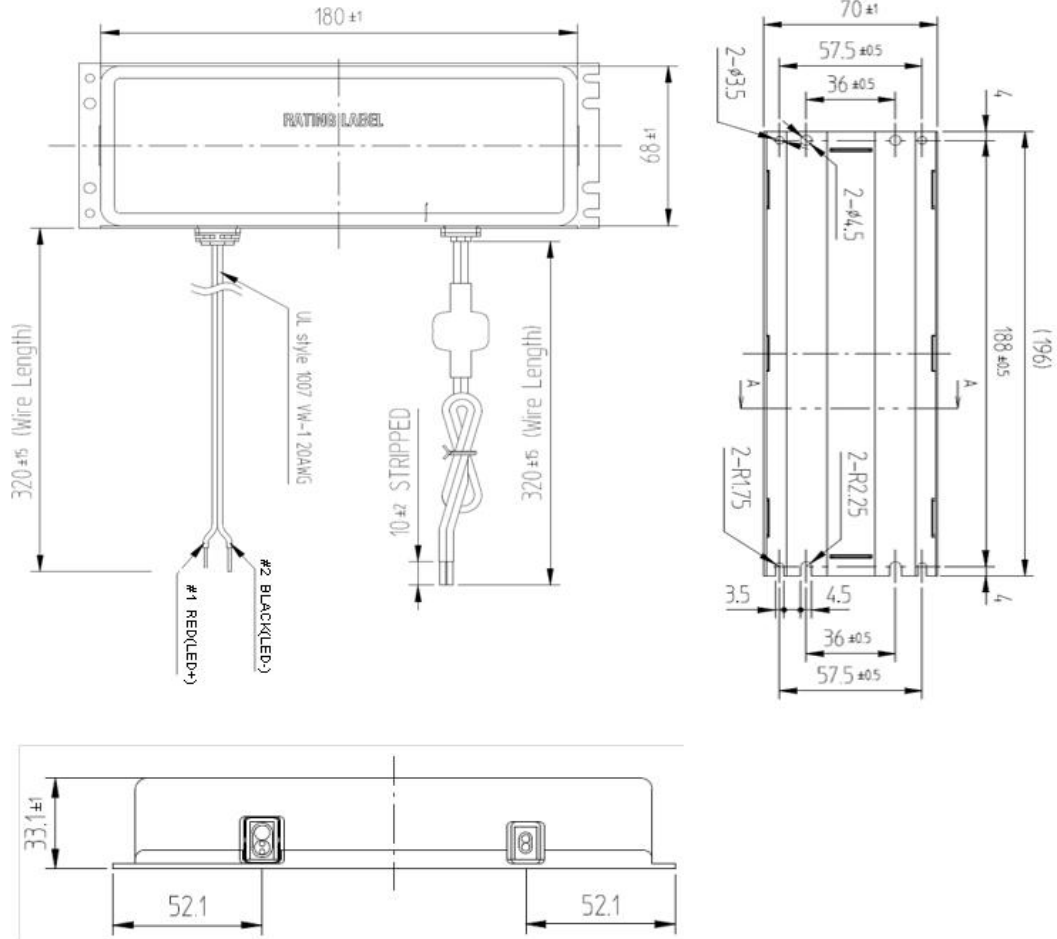

■ Metal Enclosure Size

Unit	Case Width	Case Length	Case Height	Mount Length	Overall Length
mm	70	180	33	188	196
inch	2.76	7.09	1.30	7.40	7.72

■ Case Material : Aluminium

SAMSUNG ELECTRO-MECHANICS CO., LTD

150, Maeyoung-Ro, Youngtong-Gu, Suwon-Si, Gyeonggi-Do, Republic of Korea 443-743

TEL: +82-31-210-5114, www.samsungsem.co.kr



ELECTRO-MECHANICS

50W Single Output LED Driver

PSDV500105U

■ Wiring Diagram

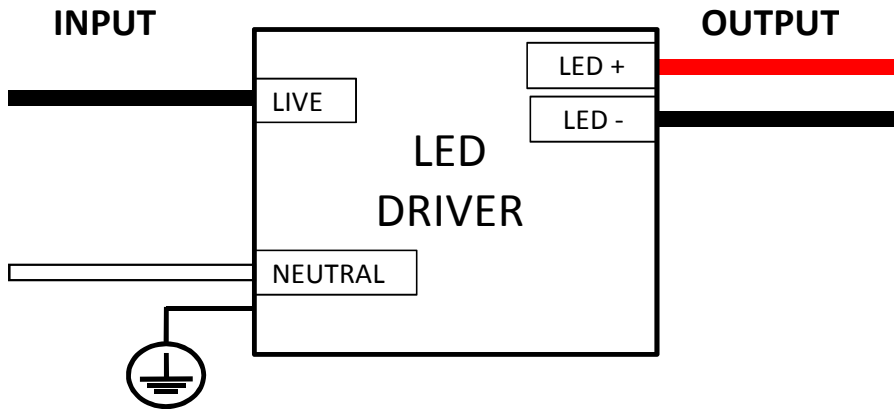

Remark) Output wiring specifications can be changed.

■ Rating Label Drawing

LED Driver Model : PSDV500105U

INPUT : 100-277V~, 50/60Hz, 70W, Max 0.8A, λ=0.9
 OUTPUTS : 30-45.3V= / 1200mA

Ta = -40°C ~ 50°C, Tc = 90°C

DIAGRAM OF INPUT/OUTPUT CONNECTION:

■ tc

CAUTION:
 Suitable for dry and damp locations.
 Do not open the case, hazardous voltage inside.
 Install in accordance with national and local electrical code.
 This product is used for LED module only.

Made in China Dongguan SAMSUNG ELECTRO-MECHANICS

Technical Support : www.sem.samsung.com

SAMSUNG ELECTRO-MECHANICS CO., LTD

150, Maeyoung-Ro, Youngtong-Gu, Suwon-Si, Gyeonggi-Do, Republic of Korea 443-743

TEL: +82-31-210-5114, www.samsungsem.co.kr