



OLB420P901N1A Flickerless Power supply

PSOH420901A



■ Model Name : PSOH420901A
OLB420P901N1A

■ Features :

- Flickerless LED control gear
- Independent type LED control gear & Class II construction
- Full-protection provided: OCP/OVP/OTP/SCP/OLP
- Compliant with CB, CE, KC safety requirements for LED lighting
- Compliant with IP 67(Ingress Protection rating)
- Wide Vout : 23 ~ 43Vdc
- Non dimming
- Constant Current Type



SOLUM Co., Ltd

150, Maeyoung-Ro, Youngtong-Gu, Suwon-Si, Gyeonggi-Do, Republic of Korea 443-743

TEL: +82-1588-0502, www.solu-m.com

■ Electrical specification

No.	Item	Min	Typ	Max	Unit	Remark	
1	Nominal Input Voltage	220	230	240	Vac		
2	Variable Input Voltage	198	-	264	Vac		
3	Maximum Input Current	-	-	0.35	Arms		
4	Nominal Input Frequency	47	50/60	63	Hz		
5	Power Factor (PF)	90	-	-	%	1)	
6	Total Harmonic Distortion (THD)	-	-	13	%	1)	
7	Inrush Current	-	-	77	A		
8	Electrical Efficiency	87	89	-	%	2)	
9	Turn-on Delay	-	-	1	sec	@Cold Start, 3)	
10	LED Output Current	859.8	905	950.3	mA	@36Vdc Load	
11	LED Output Current Ripple	-	-	90	mA	20MHz Bandwidth, 2)	
12	LED Output Voltage	23	36	43	Vdc		
13	12V Output Voltage	-	-	-	Vdc	N.A	
14	12V Output Voltage Ripple	-	-	-	Vdc	N.A	
15	12V Output Current	-	-	-	mA	N.A	
16	No Load STBY Power Dissipation	-	-	1	W	@LED Open	
17	Output Open LED Protection	-	-	58	Vpeak	@Vpeak	
18	Output Short Circuit Protection	-	-	-		Auto-recovery	
19	Over-temperature Protection	-	-	-	°C	Auto-recovery	
20	Storage Temperature	-40	25	80	°C		
21	Operating Temperature	-40	25	50	°C		
22	Case Temperature (Tc)	-	-	85	°C		
23	Humidity	20	-	85	%		
24	Insulation Resistance	10	-	-	MΩ	500Vdc between Input & Output	
25	Dielectric Withstand Voltage	Input to Output	3.75	-	-	Vac	Apply for 1 minute 8)
26		Input to Case	3.75	-	-	Vac	
27		Output to Case	0.5	-	-	Vdc	
28	Surge	Line to Line	4	6	-	kV	4)
29		Line to Ground	6	8	-	kV	4) 5)
30	ESD	Contact Discharge	4	-	-	kV	6)
31		Air Discharge	8	-	-	kV	6) 7)

SOLUM Co., Ltd

150, Maeyoung-Ro, Youngtong-Gu, Suwon-Si, Gyeonggi-Do, Republic of Korea 443-743

TEL: +82-1588-0502, www.solu-m.com

Notes

- 1) Test Condition:198/264Vac 50/60Hz Input,Typical LED Load ,Ambient Temperature 25°C,
Measure at the cable-end
- 2) Test Condition: 220Vac 60Hz Input, LED Max. Load, 30min Aging, Ambient Temperature 25°C
- 3) At least, Turn-On Time should be continued for 1sec.
- 4) Surge Specification above is higher than IEC/EN 61000-4-5 (Differential 1kV, Common 2kV)
- 5) The metal case of the LED driver must be connected with F.G
- 6) ESD Specification above meets IEC/EN 61000-4-2 Requirements (Contact 4kV, Air 8kV)
- 7) The metal case of the driver should be grounded.
- 8) Determined by Paragraph 34.1.2, UL1310 or Paragraph 8.4.2, UL8750, EN61347-1, EN61347-2-13

Safety Standards

Including safety requirements above, the LED driver complies with the following safety standards:

No.	Item	Description
1	IEC/EN 61347-1, IEC/EN 61347-2-13	IEC/EN Safety Standards
2	KC	K61347-1, K61347-2-13, K62384
3	IEC/EN 55015	Conducted and Radiated Emission Test
4	IEC/EN 61000-3-2	Harmonic current emissions: Class C
5	IEC/EN 61000-3-3	Voltage Fluctuations and Flicker
6	IEC/EN 61000-4-2	Electrostatic Discharge (ESD): Contact 4kV, Air 8kV
7	IEC/EN 61000-4-3	Radio-frequency Electromagnetic Fields
8	IEC/EN 61000-4-4	Electrical Fast Transients (EFT)
9	IEC/EN 61000-4-5	Surges: Differential 1kV, Common 2kV
10	IEC/EN 61000-4-6	Injected Currents
11	IEC/EN 61000-4-8	Power Frequency Magnetic Fields
12	IEC/EN 61000-4-11	Voltage Dips and Short Interruptions
13	IP GRADE	IP 67

SOLUM Co., Ltd

150, Maeyoung-Ro, Youngtong-Gu, Suwon-Si, Gyeonggi-Do, Republic of Korea 443-743

TEL: +82-1588-0502, www.solu-m.com

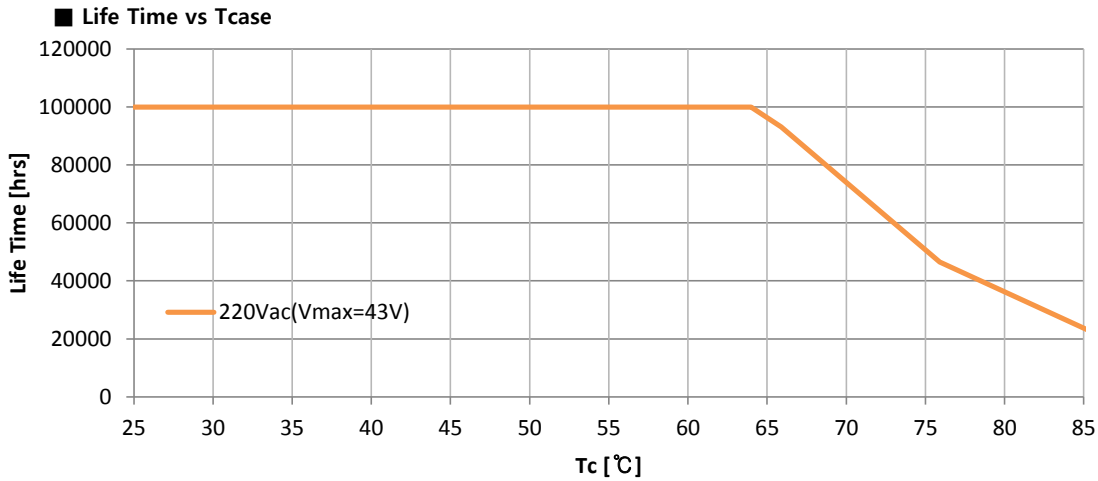

Remark) LED Driver has a rated lifetime of 50,000 hours @ Tc ≤ 70°C

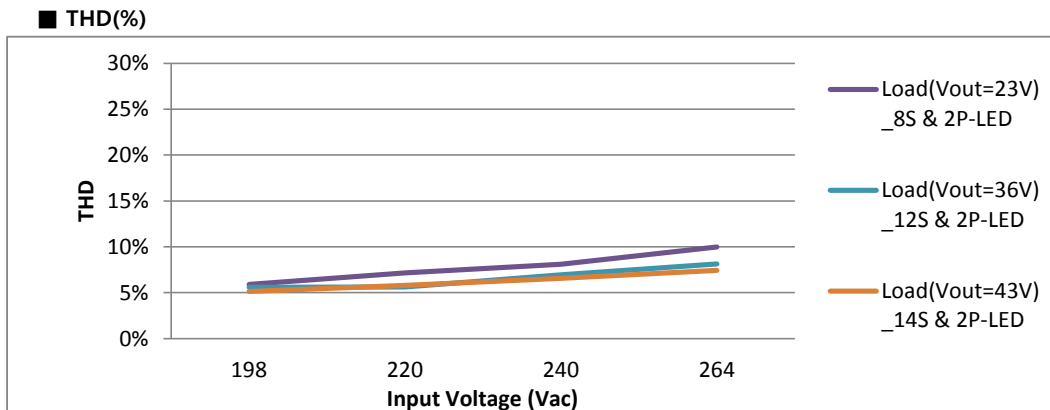
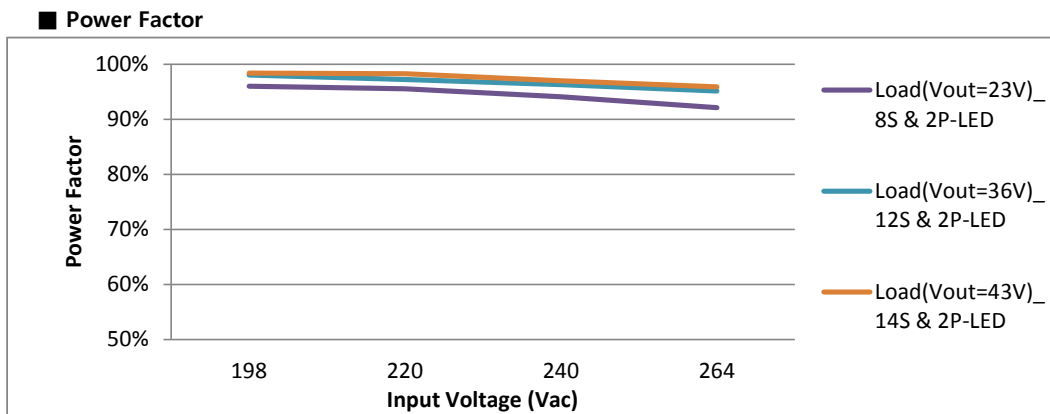

SOLUM Co., Ltd

150, Maeyoung-Ro, Youngtong-Gu, Suwon-Si, Gyeonggi-Do, Republic of Korea 443-743

TEL: +82-1588-0502, www.solu-m.com

■ Efficiency(%)

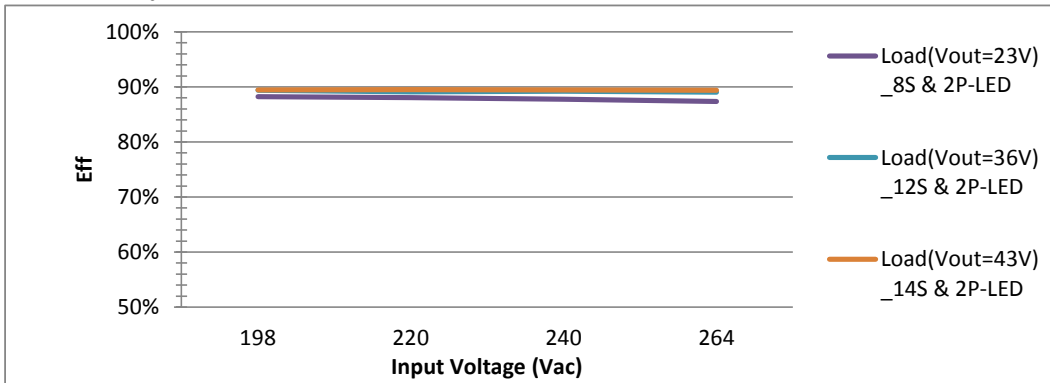

■ Output Current(mA)

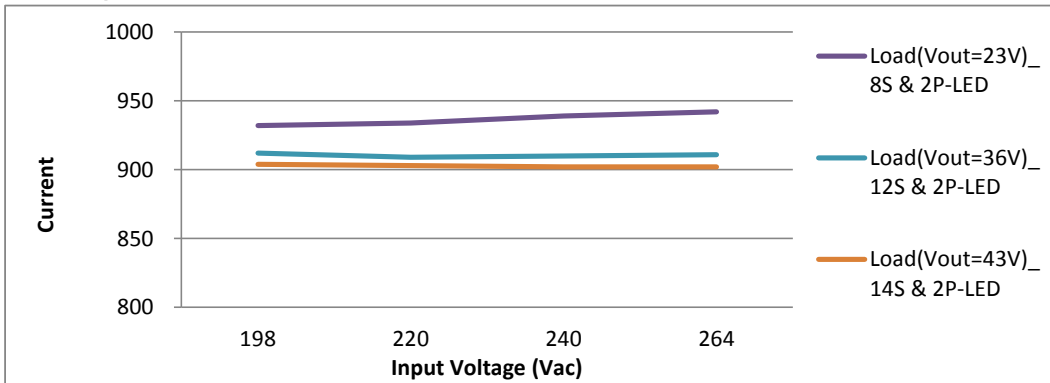

SOLUM Co., Ltd

150, Maeyoung-Ro, Youngtong-Gu, Suwon-Si, Gyeonggi-Do, Republic of Korea 443-743

TEL: +82-1588-0502, www.solu-m.com

■ Mechanical Specification

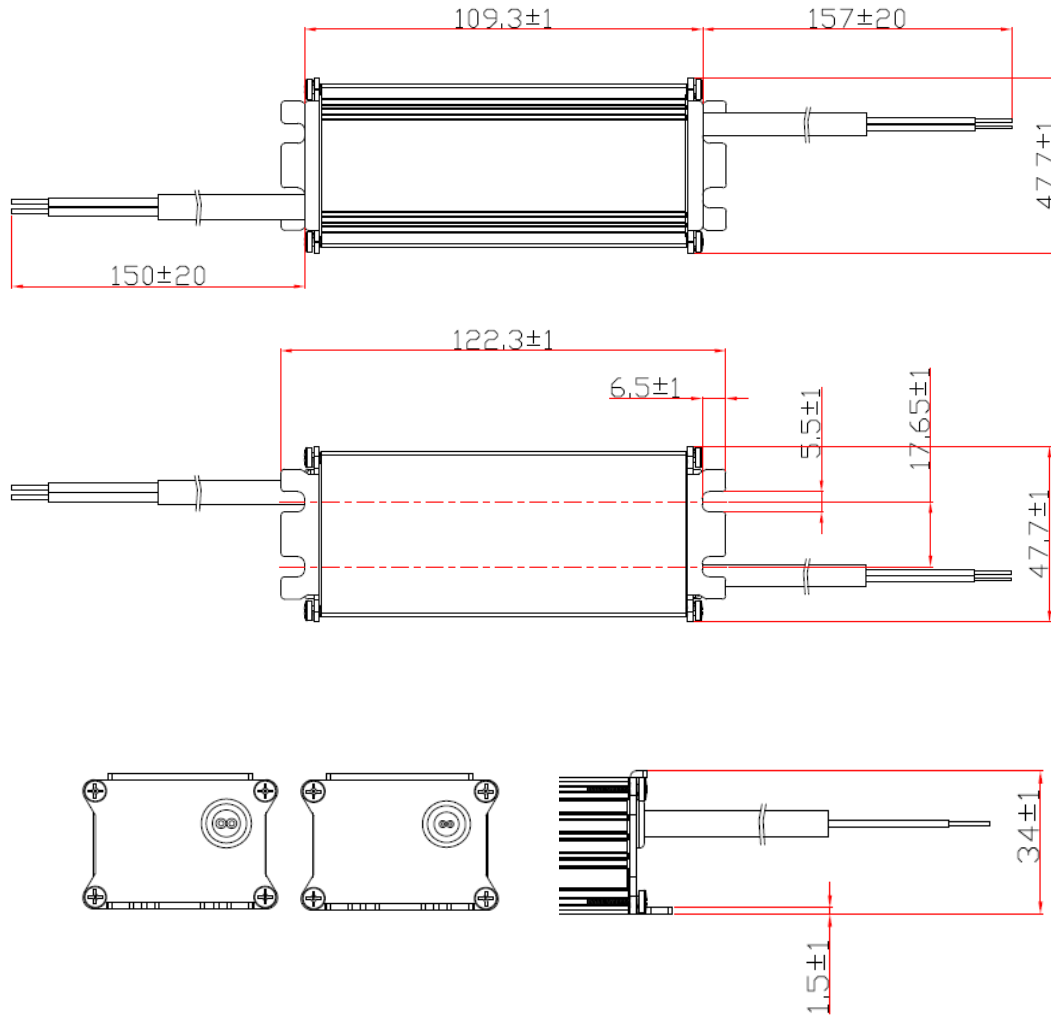

■ Enclosure Size

Unit	Width	Length	Height	Mount Length	Overall Length
mm	47.7	109.3	34.0	122.3	416.3
inch	1.88	4.30	1.34	4.81	16.39

■ Case Material : Aluminium

SOLUM Co., Ltd

150, Maeyoung-Ro, Youngtong-Gu, Suwon-Si, Gyeonggi-Do, Republic of Korea 443-743

TEL: +82-1588-0502, www.solu-m.com

■ Wiring Diagram

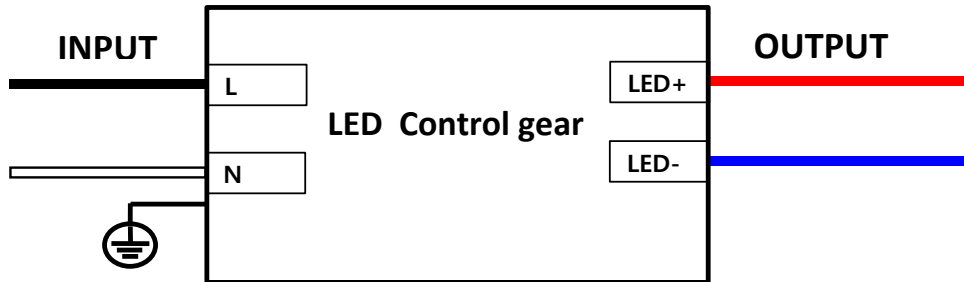

■ Out connector description

Classification	Part No.	Connector (Cable end)	Connector (Opposite side)
Type#1	PSOH420901A	N.A	N.A
Type#2	PSOH420901B	MG610320(KET)	MG610322(KET)
Type#3	PSOH420901C	02R-JWPF-VSLE-S(JST) or 02R-JWPKF-VKLE-S(JST)	02T-JWPF-VSLE-S(JST) or 02T-JWPKF-VKLE-S(JST)

■ Rating Label Drawing

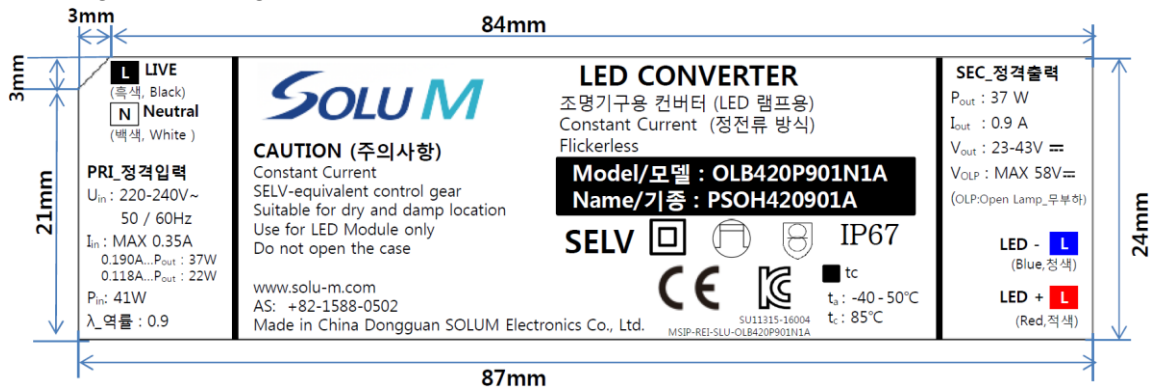

SOLUM Co., Ltd

150, Maeyoung-Ro, Youngtong-Gu, Suwon-Si, Gyeonggi-Do, Republic of Korea 443-743

TEL: +82-1588-0502, www.solu-m.com



OLB420P901N1A Flickerless Power supply

PSOH420901A

Barcode Label

2016-01-01 PSOH420901A

C 1 1 5 A 2 2 2 0 3 0 0 0 1 REV.A01

DATE / MODEL NAME
 BARCODE
 LOT NO

7 DEVELOPMENT Rev X01~99
 MP Rev A01~99
 6 SERIAL No 4 Digit
 5 MODEL CODE 3 Digit
 4 PRODUCTION DATE 2 Digit
 3 PRODUCTION MONTH 1 Digit
 2 PRODUCTION YEAR 2 Digit
 1 PRODUCTION COUNTI 2 Digit

Mean	1.PLANT	2. YEAR	3. MONTH	4. DATE	5. CODE	6. SERIAL	7. Revision No
Digit	2	2	1	2	3	4	
EX.	C1 : DGSM C2 : Solytech C3 : IM C4 : Ap tech K1 : Korea	00~99	1...9,A,B	01~31	203	0001.. 9999	X01~99 : DEVELOPMENT A01~99: MP

Box Label

Material Code	OLB420P901N1A		USER Model Code																																					
ITEM	PSOH420901A REV. A**		SOLUM Model Code																																					
LOT No	*****	MAKER	SOLUM LOT NO & Quantity of Products																																					
Quantity [PCS]	21	SOLUM	<table border="1"> <thead> <tr> <th>Year</th> <th>Month</th> <th>Date</th> <th>Factory</th> <th>Fixed</th> </tr> </thead> <tbody> <tr> <td>22</td> <td>23</td> <td>24</td> <td>25</td> <td>26</td> <td>27</td> <td>28</td> <td>29</td> <td>30</td> </tr> <tr> <td>P</td> <td>0</td> <td>1</td> <td>0</td> <td>1</td> <td>D</td> <td>0</td> <td>0</td> <td>1</td> </tr> <tr> <td>N→2015</td> <td rowspan="4">01~12月</td> <td rowspan="4">01~31日</td> <td colspan="2">D : DGSM</td> </tr> <tr> <td>P→2016</td> <td colspan="2">S : Solytech</td> </tr> <tr> <td>Q→2017</td> <td colspan="2">M : IM</td> </tr> <tr> <td>R→2018</td> <td colspan="2">A : Aptech</td> </tr> </tbody> </table>	Year	Month	Date	Factory	Fixed	22	23	24	25	26	27	28	29	30	P	0	1	0	1	D	0	0	1	N→2015	01~12月	01~31日	D : DGSM		P→2016	S : Solytech		Q→2017	M : IM		R→2018	A : Aptech	
Year	Month	Date		Factory	Fixed																																			
22	23	24		25	26	27	28	29	30																															
P	0	1		0	1	D	0	0	1																															
N→2015	01~12月	01~31日	D : DGSM																																					
P→2016			S : Solytech																																					
Q→2017			M : IM																																					
R→2018			A : Aptech																																					
EXP. Date	20**.**.** ~ 20**.**.**		Product Date ~ After 5 years																																					
	 000000084B001 E601 P0315D001		USER Barcode																																					

Digit	Quantity Per BOX									BOX Size	Serial No.				Blank	Vender Code					Blank	Year	Month	Date	Factory	Fixed						
	1	2	3	4	5	6	7	8	9	10	11	12	13	14	15	16	17	18	19	20	21	22	23	24	25	26	27	28	29	30		
	0	0	0	0	0	0	0	1	0	B	0	0	1		E	6	0	1				P	0	1	0	1	D	0	0	1		
											A : Pallet B : BOX	001~999																				

SOLUM Co., Ltd

150, Maeyoung-Ro, Youngtong-Gu, Suwon-Si, Gyeonggi-Do, Republic of Korea 443-743

TEL: +82-1588-0502, www.solu-m.com

