



■ **Model Name :** OLU700P142U1A
 PSOV700142C

■ **Features :**

- Flickerless
- Full-protection provided: OCP/OVP/OTP/SCP/OLP
- Low Power Dissipation (Stand-by mode : <0.5Wh)
- Wide Vout : 25 ~ 43Vdc
- Compliant with CB, CE, KC safety requirements for LED lighting
- Constant Current Type
- IP 67



SOLUM CO., LTD

150, Maeyoung-Ro, Youngtong-Gu, Suwon-Si, Gyeonggi-Do, Republic of Korea 443-743

TEL: +82-1588-0502, www.solu-m.com

■ Electrical specification

No.	Item	Min	Typ	Max	Unit	Remark	
1	Nominal Input Voltage	120	220	277	Vac		
2	Variable Input Voltage	108	-	300	Vac		
3	Maximum Input Current	-	-	0.7	Arms		
4	Nominal Input Frequency	47	50/60	63	Hz		
5	Power Factor (PF)	90	-	-	%	1)	
6	Total Harmonic Distortion (THD)	-	-	20	%	1)	
7	Inrush Current	-	-	65	A		
8	Electrical Efficiency	85	88	-	%	2)	
9	Turn-on Delay	-	-	0.5	s	@Cold Start, 3)	
10	LED Output Current	1330	1400	1470	mA	@43Vdc Load	
11	LED Output Current Ripple	-	-	140	mA	20MHz Bandwidth, 2)	
12	LED Output Voltage	25	-	43	Vdc		
13	Adjustable of LED Current	1050	-	1400	mA	Rset	
14	12V Output Voltage	10.8	12	13.2	Vdc	2)	
15	12V Output Voltage Ripple	-	-	± 1.2	Vdc	20MHz Bandwidth, 2)	
16	12V Output Current	-	-	100	mA		
17	STBY Power Dissipation	-	-	0.5	Wh	LED Off_Remote Low	
18	Output Open LED Protection	-	-	59	Vdc	@Vpeak	
19	Output Short Circuit Protection	-	-	-	-	No Damage	
20	Storage Temperature	-40	25	80	°C		
21	Operating Temperature	-40	25	50	°C		
22	Case Temperature (Tc)	-	50	85	°C	Ta = 55°C	
23	Humidity	20	-	85	%		
24	Insulation Resistance	10	-	-	MΩ	500Vdc between Input & Output	
25	Dielectric Withstand Voltage	Input to Output	3.75	-	-	kV	Apply for 1 minute 6)
26		Input to Case	3.75	-	-	kV	
27		Output to Case	0.5	-	-	kV	
28	Surge	Line to Line	6	7	-	kV	4)
29		Line to Ground	8	9	-	kV	4)
30	ESD	Contact Discharge	4	-	-	kV	5)
31		Air Discharge	8	-	-	kV	5)

SOLUM CO., LTD

150, Maeyoung-Ro, Youngtong-Gu, Suwon-Si, Gyeonggi-Do, Republic of Korea 443-743

TEL: +82-1588-0502, www.solum.com

☞ Application Notes

- 1) Test Condition: 120/277Vac 50/60Hz Input, Typical LED Load, Ambient Temperature 25°C, Measure at the cable-end
- 2) Test Condition: 220Vac 60Hz Input, LED Max. Load, 30min Aging, Ambient Temperature 25°C
- 3) The interval of turn on/off should be over 1sec.
- 4) Surge Specification above is higher than IEC/EN 61000-4-5 Level 4 (Differential 2kV, Common 4kV)
- 5) The metal case of the LED driver must be connected with F.G
- 6) ESD Specification above meets IEC/EN 61000-4-2 Requirements (Contact Level 2, Air Level 3)
- 7) The metal case of the driver should be grounded.
- 8) Determined by Paragraph 34.1.2, UL1310 or Paragraph 8.4.2, UL8750, EN61347-1, EN61347-2-13

☞ Safety Standards

Including safety requirements above, the LED driver complies with the following safety standards:

No.	Item	Description
1	IEC/EN 61347-1, IEC/EN 61347-2-13	IEC/EN Safety Standards
2	IEC/EN 55015	Conducted and Radiated Emission Test
3	IEC/EN 61000-3-2	Harmonic current emissions: Class C
4	IEC/EN 61000-3-3	Voltage Fluctuations and Flicker
5	IEC/EN 61000-4-2	Electrostatic Discharge (ESD): Contact Level 2, Air Level 3
6	IEC/EN 61000-4-3	Radio-frequency Electromagnetic Fields
7	IEC/EN 61000-4-4	Electrical Fast Transients (EFT)
8	IEC/EN 61000-4-5	Surges: Level 4
9	IEC/EN 61000-4-6	Injected Currents
10	IEC/EN 61000-4-8	Power Frequency Magnetic Fields
11	IEC/EN 61000-4-11	Voltage Dips and Short Interruptions

SOLUM CO., LTD

150, Maeyoung-Ro, Youngtong-Gu, Suwon-Si, Gyeonggi-Do, Republic of Korea 443-743

TEL: +82-1588-0502, www.solu-m.com

■ **Operating window (TBD)**

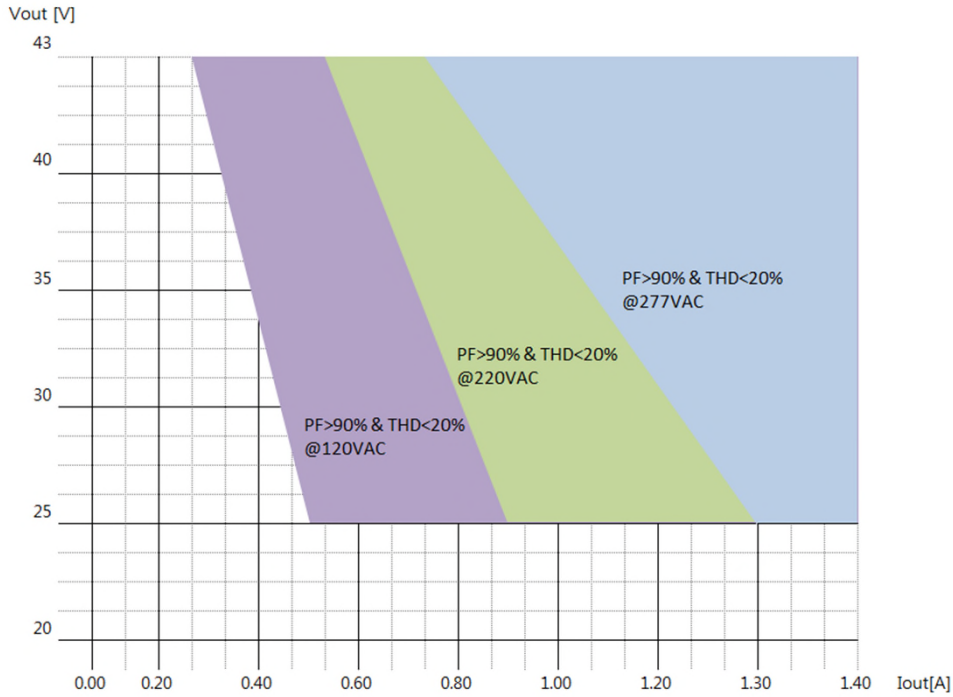

■ **Life Time vs Tcase (TBD)**

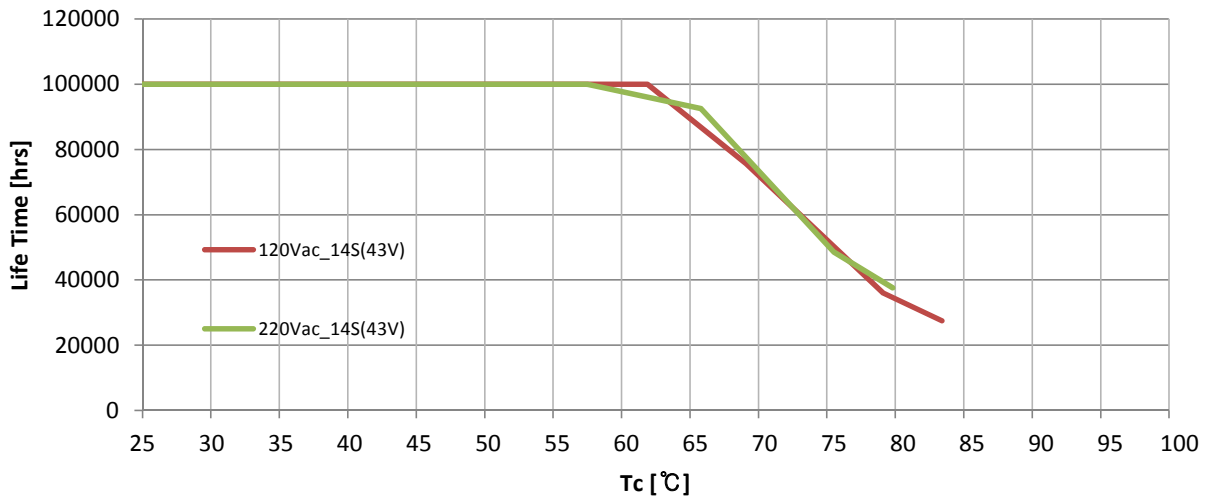

Remark) LED Driver has a rated lifetime of 50,000 hours @ Tc ≤ 65°C

SOLUM CO., LTD

150, Maeyoung-Ro, Youngtong-Gu, Suwon-Si, Gyeonggi-Do, Republic of Korea 443-743

TEL: +82-1588-0502, www.solu-m.com

*Currently Measurement Data

■ Power Factor

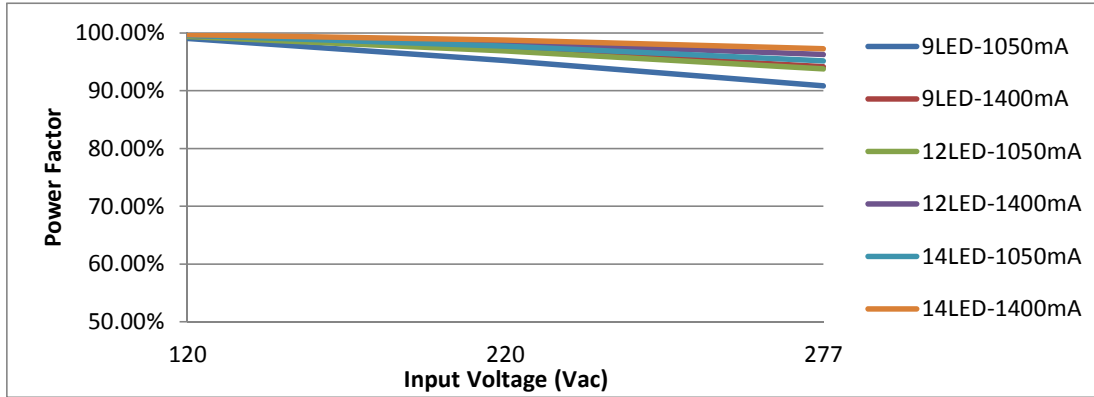

■ THD(%) (TBD)

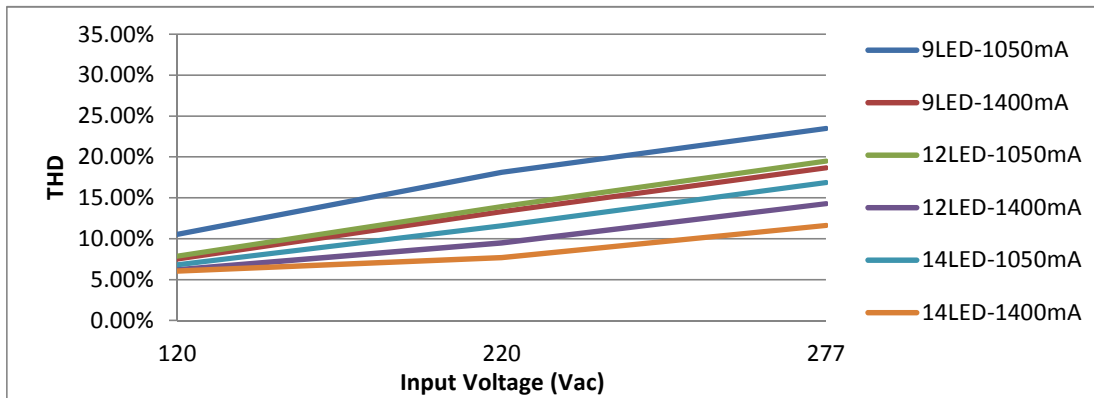

■ Efficiency(%)

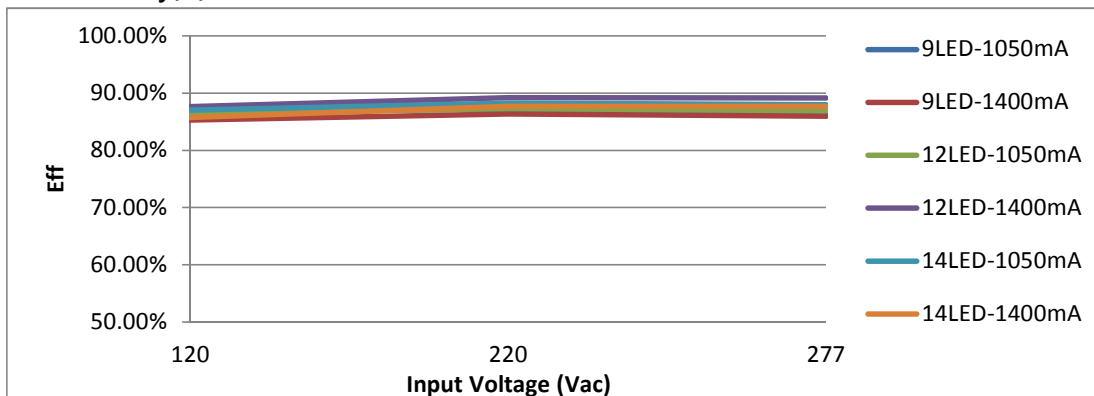

SOLUM CO., LTD

150, Maeyoung-Ro, Youngtong-Gu, Suwon-Si, Gyeonggi-Do, Republic of Korea 443-743

TEL: +82-1588-0502, www.solu-m.com

*Currently Measurement Data

■ Output Current(mA)

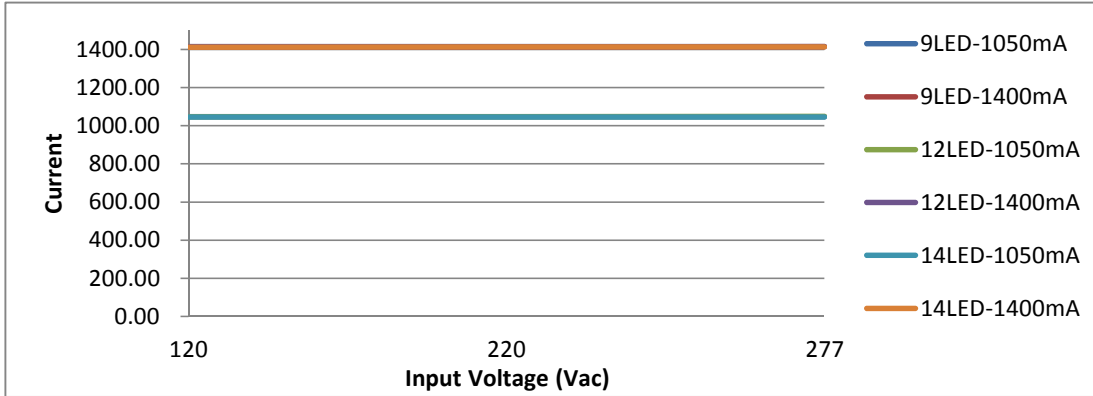

■ Diming curve

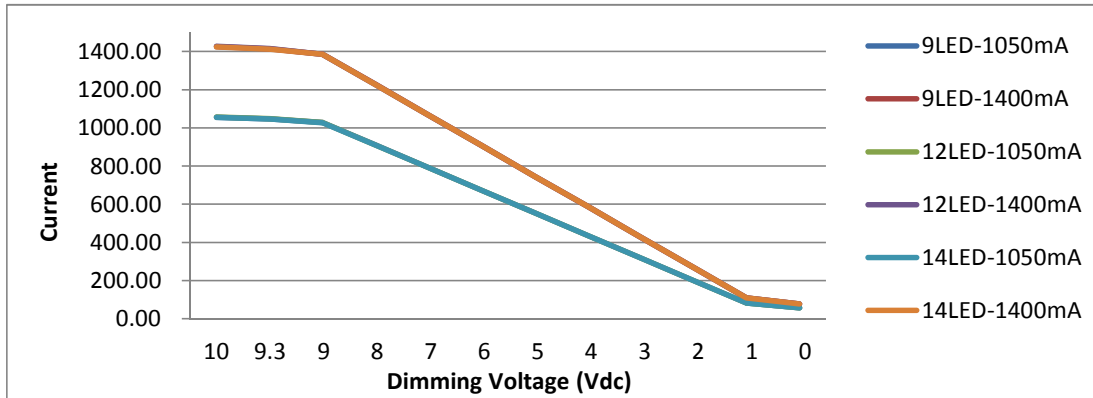

■ Adjustable Of Current

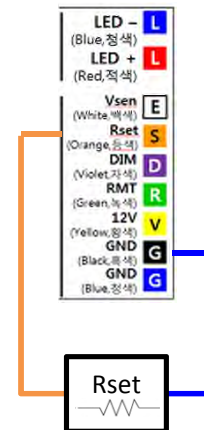
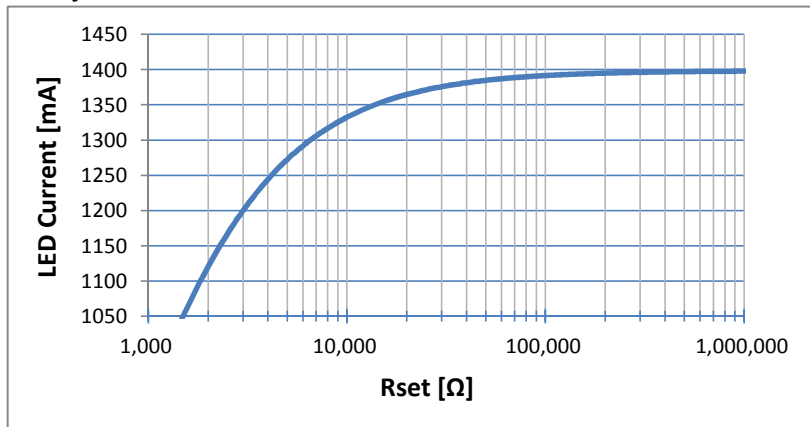

SOLUM CO., LTD

150, Maeyoung-Ro, Youngtong-Gu, Suwon-Si, Gyeonggi-Do, Republic of Korea 443-743

TEL: +82-1588-0502, www.solu-m.com

■ Mechanical Specification

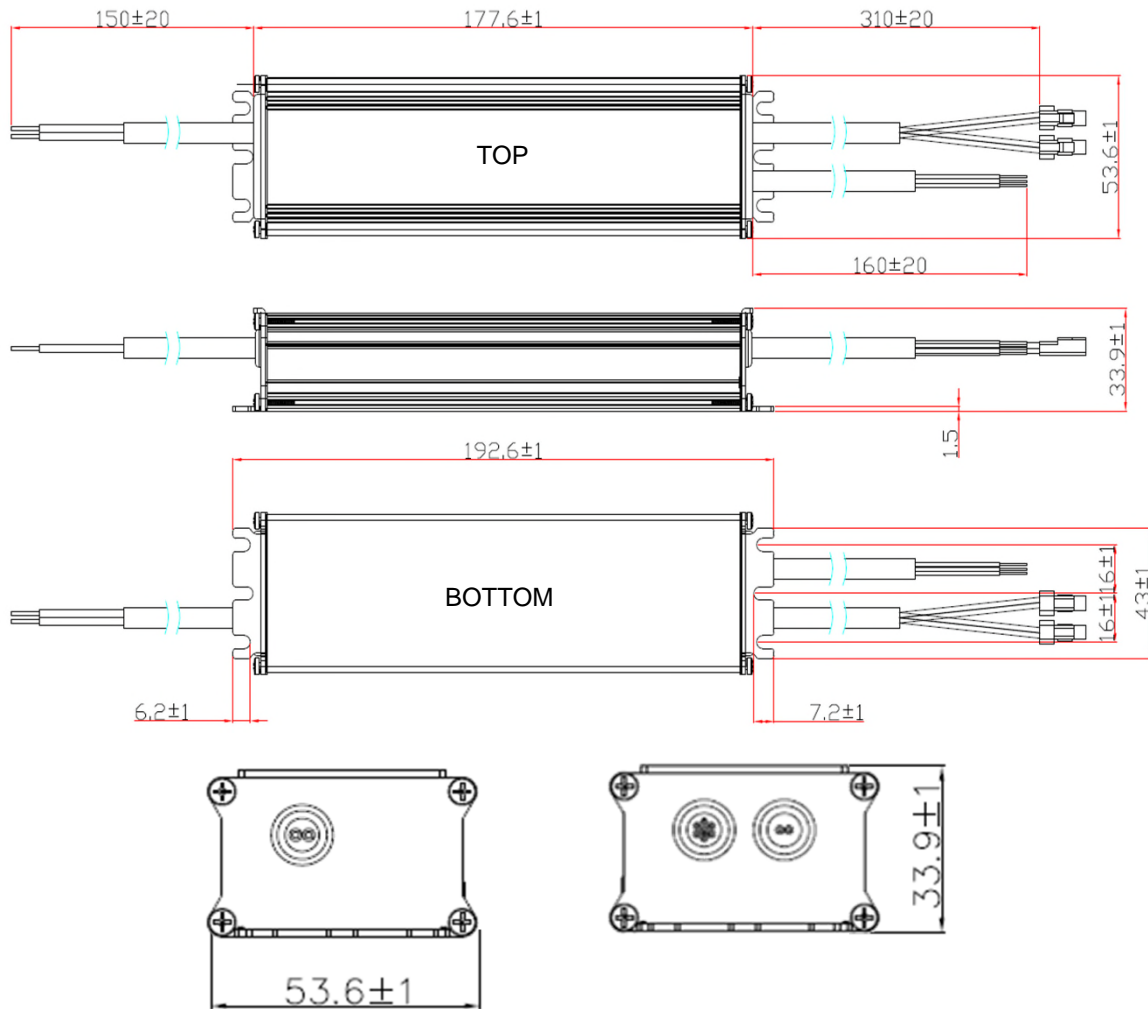

■ Enclosure Size

Unit	Width	Length	Height	Mount Length	Overall Length
mm	53.6	177.6	33.9	185.4	192.6
inch	2.11	6.99	1.33	7.30	7.58

■ Case Material : Aluminium

SOLUM CO., LTD

150, Maeyoung-Ro, Youngtong-Gu, Suwon-Si, Gyeonggi-Do, Republic of Korea 443-743

TEL: +82-1588-0502, www.solu-m.com

Wiring Diagram

LIVE : Black/Blown
 Neutral : White/Blue

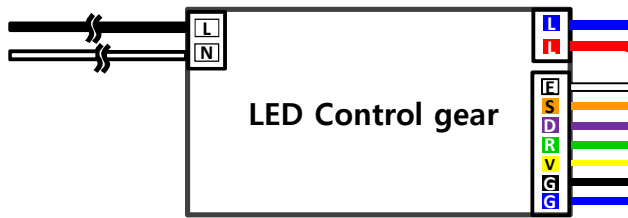

LED + : Red
 LED - : Blue

Vsen : White
 Rset : Orange
 DIM : Violet
 RMT : Green
 12V : Yellow
 GND : Black
 GND : Blue

Out connector description

Model	Part No.	Classification	Connector(Cable end)	Connector(opposite side)
OLU700P142U1A	PSOV700142A	Type#1	N.A	N.A
	PSOV700142B	Type#2	MG610320(KET)	MG640322(KET)
	PSOV700142C	Type#3	02R-JWPF-VSLE-S(JST) 02R-JWPKF-VKLE-S(JST) K500140-02 (KET)	02T-JWPF-VSLE-S(JST) 02T-JWPKF-VKLE-S(JST) K500139-02 (KET)

※ Caution

- 1) Before installing LED driver, AC power should be turned off.
 After installing LED driver, AC power should be turned on.
- 2) When this LED driver are installed as an independent lamp controlgear, end-customer should protect connecting leads of pri/sec. cable with a certified element.
- 3) Waterproof connector or Junction box can be assembled with output cables for operating in dry/wet/damp or outdoor environment.
- 4) Wires should be less than 1m when installed in final equipment

2nd Signal Description

Name	Feature	Purpose
Vsen	check LED Out Voltage	Monotoring LED Open/Short (for Connectivity Module)
Rset	Adjustable of current	Control LED Output Current
DIM	Dimming	Control Brightness
RMT	LED On/Off	Stand by Mode
12V	Control Source	Supply Controller Power
GND	2nd GND	Signal GND
GND	2nd GND	Signal GND

Rating Label Drawing

<p>L LIVE (검색, Black) (갈색, Brown)</p> <p>N Neutral (흰색, White) (파란색, Blue)</p> <p>PR1 정격입력 U_{in} : 120 - 277V~ 50/60 Hz I_{in} : Max. 0.7A 0.34A_220Vac,60Hz P_{in} : 82W λ_{역률} : 0.9</p>	<p>CAUTION (주의사항) Suitable for dry and damp location Use for LED Module only Do not open the case</p> <p>Hillsite Am Kronberger Hang 8, 65824 Schwalbach Ts. Germany. www.solu-m.com AS : +82-1588-0502</p>	<p>LED CONVERTER 조명기구용 컨버터 (LED 램프용) Constant Current (정전류 방식) ■ tc Flickerless / Unified Dim / Rset</p> <p>Model/모델 : OLU700P142U1A Name/기종 : PSOV700142C</p> <p>SELV </p> <p>SU11315-16013 MSP-REB-SLU-OLU700P142U1A</p>	<p>IP67</p> <p>SEC_정격출력 P_{out} : 65W I_{out} : 1.4A V_{out} : 25 - 43V = V_{OLP} : Max. 59V = (OLP : Open Lamp_무부하)</p> <p>12V_12V출력 P_{out} : 1.5W I_{out} : 0.100A V_{out} : Max. 13.2V =</p>	<p>LED</p> <p>LED - L (Blue, 파란)</p> <p>LED + T (Red, 검색)</p> <p>Vsen E (White, 흰색)</p> <p>Rset S (Orange, 갈색)</p> <p>DIM D (Violet, 보라색)</p> <p>RMT R (Green, 녹색)</p> <p>12V V (Yellow, 노란)</p> <p>GND G (Black, 검색)</p> <p>GND G (Blue, 파란)</p>
--	--	---	---	---

SOLUM CO., LTD

150, Maeyoung-Ro, Youngtong-Gu, Suwon-Si, Gyeonggi-Do, Republic of Korea 443-743

TEL: +82-1588-0502, www.solu-m.com

■ Barcode Label



DATE
 BARCODE
 LOT NO

- 7 DEVELOPMENT Rev X01~99
- MP Rev A01~99
- 6 SERIAL No _4 Digit
- 5 MODEL CODE _3 Digit
- 4 PRODUCTION DATE _2 Digit
- 3 PRODUCTION MONTH _1 Digit
- 2 PRODUCTION YEAR _2 Digit
- 1 PRODUCTION COUNTRY _2 Digit

Mean	1.PLANT	2. YEAR	3. MONTH	4. DATE	5. CODE	6. SERIAL	7. Revision No
Digit	2	2	1	2	3	4	
EX.	C1 : DGSM C2 : Solytech C3 : IM C4 : Ap tech K1 : Korea	00~99	1...9,A,B	01~31	264	0001.. 9999	X01~99 : DEVELOPMENT A01~99: MP

■ Box Label

Material Code	OLU700P142U1A		→ USER Model Code
ITEM	PSOV700142C REV. A**		→ SOLUM Model Code
LOT No	*****	MAKER	→ SOLUM LOT NO & Quantity of Products
Quantity [PCS]	24	SOLUM	
EXP. Date	20**.**.* ~ 20**.**.*		→ Product Date ~ After 5 years
***** **			→ USER Barcode

Digit	Year		Month		Data		Factory		Fixed	
	1	2	3	4	5	6	7	8	9	
N	0	5	1	2	D	0	0	1		
M→2014	01~12月		01~31日		D : DSEM					
N→2015					S : Solytech					
P→2016					M : IM					
Q→2017					A : Aptech					

Digit	Quantity Per BOX									BOX Size	Serial No.				Blank	Vender Code					Blank	Year	Month		Data		Factory		Fixed	
	1	2	3	4	5	6	7	8	9	10	11	12	13	14	15	16	17	18	19	20	21	22	23	24	25	26	27	28	29	30
	0	0	0	0	0	0	0	4	2	B	0	0	1	E	6	0	1				N	0	5	1	2	D	0	0	1	
										A : Pallet B : BOX	001~999					M→2014 N→2015 P→2016 Q→2017						01~12月		01~31日		D : DSEM S : Solytech M : IM A : Aptech				

SOLUM CO., LTD

150, Maeyoung-Ro, Youngtong-Gu, Suwon-Si, Gyeonggi-Do, Republic of Korea 443-743

TEL: +82-1588-0502, www.solum-m.com

■ Packing Drawing

1. Out Box

Dimension	540(L) 355(W) 170(H) [mm]
Weight	< 14Kg
Quantity	24EA / 1Box

TRY BODY

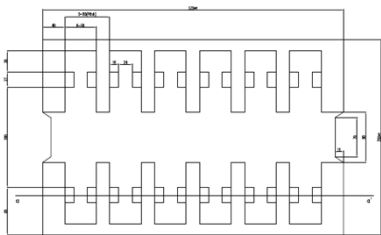

NIL PAD

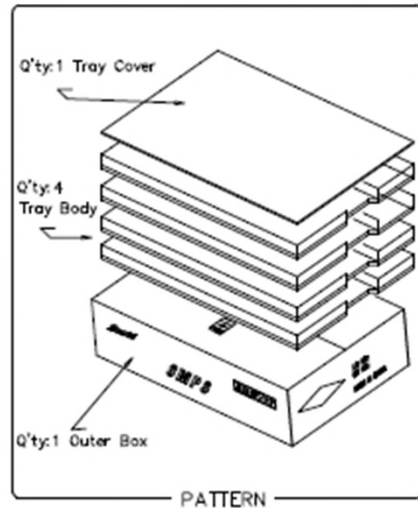
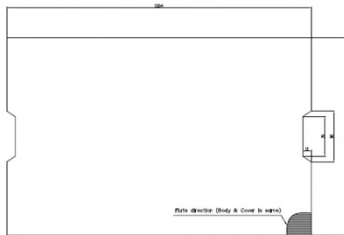

PATTERN

OUT BOX

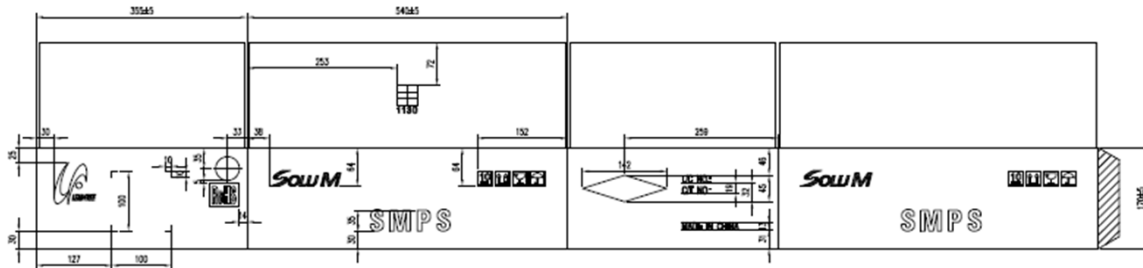

2. Pallet

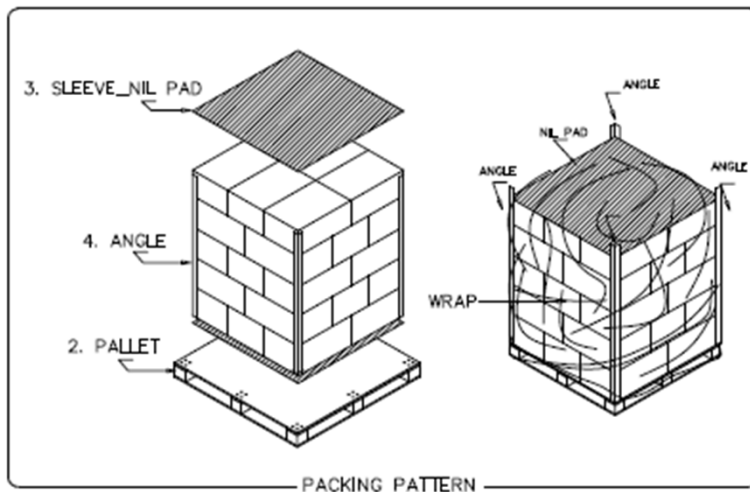

PACKING PATTERN

SOLUM CO., LTD

150, Maeyoung-Ro, Youngtong-Gu, Suwon-Si, Gyeonggi-Do, Republic of Korea 443-743

TEL: +82-1588-0502, www.solu-m.com