



OLW250P701N1A Flickerless Power supply

PSOV250701A



■ Model Name : PSOV250701A
OLW250P701N1A

■ Features :

- Flickerless LED control gear
- Independent type LED control gear & Class II construction
- Full-protection provided: OCP/OVP/OTP/SCP/OLP
- Compliant with CB, CE, KC safety requirements for LED lighting
- Compliant with IP 67(Ingress Protection rating)
- Wide Vout : 18 ~ 33Vdc
- Non dimming
- Constant Current type



SOLUM Co., Ltd

150, Maeyoung-Ro, Youngtong-Gu, Suwon-Si, Gyeonggi-Do, Republic of Korea 443-743

TEL: +82-1588-0502, www.solu-m.com

■ Electrical specification

No.	Item		Min	Typ	Max	Unit	Remark
1	Nominal Input Voltage		110	220	240	Vac	
2	Variable Input Voltage		99	-	264	Vac	
3	Maximum Input Current		-	-	0.35	Arms	
4	Nominal Input Frequency		47	50/60	63	Hz	
5	Power Factor (PF)		90	-	-	%	1)
6	Total Harmonic Distortion (THD)		-	-	13	%	1)
7	Inrush Current		-	-	77	A	
8	Electrical Efficiency		83.5	87	-	%	2)
9	Turn-on Delay		-	-	1	sec	@Cold Start, 3)
10	LED Output Current		665	700	735	mA	@30Vdc Load
11	LED Output Current Ripple		-	-	70	mA	20MHz Bandwidth, 2)
12	LED Output Voltage		18	30	33	Vdc	
13	12V Output Voltage		-	-	-	Vdc	N.A
14	12V Output Voltage Ripple		-	-	-	Vdc	N.A
15	12V Output Current		-	-	-	mA	N.A
16	No Load STBY Power Dissipation		-	-	1	W	@LED Open
17	Output Open LED Protection		-	-	54	Vpeak	@Vpeak
18	Output Short Circuit Protection		-	-	-		Auto-recovery
19	Over-temperature Protection		-	-	-	°C	Auto-recovery
20	Storage Temperature		-40	25	80	°C	
21	Operating Temperature		-40	25	50	°C	
22	Case Temperature (Tc)		-	-	85	°C	
23	Humidity		20	-	85	%	
24	Insulation Resistance		10	-	-	MΩ	500Vdc between Input & Output
25	Dielectric Withstand Voltage	Input to Output	3.75	-	-	Vac	Apply for 1 minute 8)
26		Input to Case	3.75	-	-	Vac	
27		Output to Case	0.5	-	-	Vdc	
28	Surge	Line to Line	4	6	-	kV	4)
29		Line to Ground	6	8	-	kV	4) 5)
30	ESD	Contact Discharge	4	-	-	kV	6)
31		Air Discharge	8	-	-	kV	6) 7)

SOLUM Co., Ltd

150, Maeyoung-Ro, Youngtong-Gu, Suwon-Si, Gyeonggi-Do, Republic of Korea 443-743

TEL: +82-1588-0502, www.solu-m.com

Notes

- 1) Test Condition: 99/264Vac 50/60Hz Input, Typical LED Load, Ambient Temperature 25°C, Measure at the cable-end
- 2) Test Condition: 220Vac 60Hz Input, LED Max. Load, 30min Aging, Ambient Temperature 25°C
- 3) At least, Turn-On Time should be continued for 1sec.
- 4) Surge Specification above is higher than IEC/EN 61000-4-5 (Differential 1kV, Common 2kV)
- 5) The metal case of the LED driver must be connected with F.G
- 6) ESD Specification above meets IEC/EN 61000-4-2 Requirements (Contact 4kV, Air 8kV)
- 7) The metal case of the driver should be grounded.
- 8) Determined by Paragraph 34.1.2, UL1310 or Paragraph 8.4.2, UL8750, EN61347-1, EN61347-2-13

Safety Standards

Including safety requirements above, the LED driver complies with the following safety standards:

No.	Item	Description
1	IEC/EN 61347-1, IEC/EN 61347-2-13	IEC/EN Safety Standards
2	KC	K61347-1, K61347-2-13, K62384
3	IEC/EN 55015	Conducted and Radiated Emission Test
4	IEC/EN 61000-3-2	Harmonic current emissions: Class C
5	IEC/EN 61000-3-3	Voltage Fluctuations and Flicker
6	IEC/EN 61000-4-2	Electrostatic Discharge (ESD): Contact 4kV, Air 8kV
7	IEC/EN 61000-4-3	Radio-frequency Electromagnetic Fields
8	IEC/EN 61000-4-4	Electrical Fast Transients (EFT)
9	IEC/EN 61000-4-5	Surges: Differential 1kV, Common 2kV
10	IEC/EN 61000-4-6	Injected Currents
11	IEC/EN 61000-4-8	Power Frequency Magnetic Fields
12	IEC/EN 61000-4-11	Voltage Dips and Short Interruptions
13	IP GRADE	IP 67

SOLUM Co., Ltd

150, Maeyoung-Ro, Youngtong-Gu, Suwon-Si, Gyeonggi-Do, Republic of Korea 443-743

TEL: +82-1588-0502, www.solu-m.com

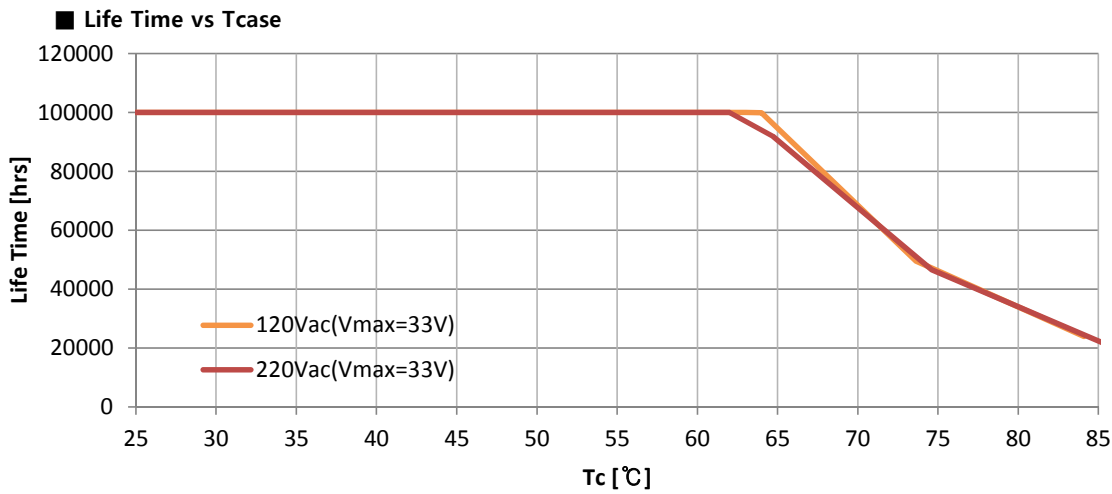

Remark) LED Driver has a rated lifetime of 50,000 hours @ T_c ≤ 70°C

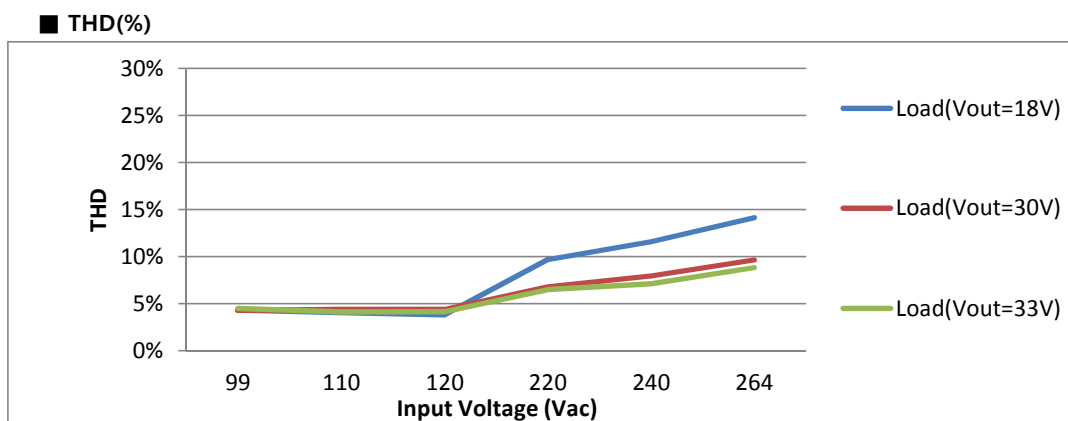
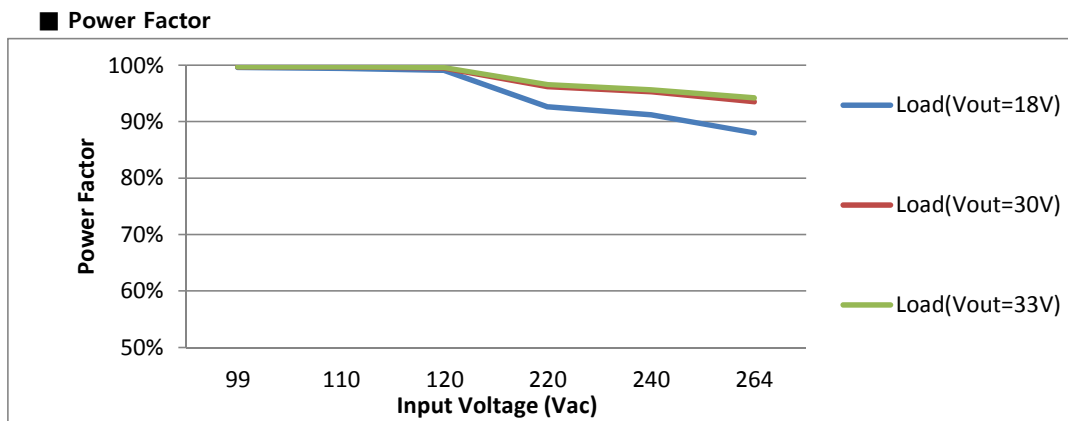

SOLUM Co., Ltd

150, Maeyoung-Ro, Youngtong-Gu, Suwon-Si, Gyeonggi-Do, Republic of Korea 443-743

TEL: +82-1588-0502, www.solu-m.com



OLW250P701N1A Flickerless Power supply

PSOV250701A

*Currently Measurement Data

■ Efficiency(%)

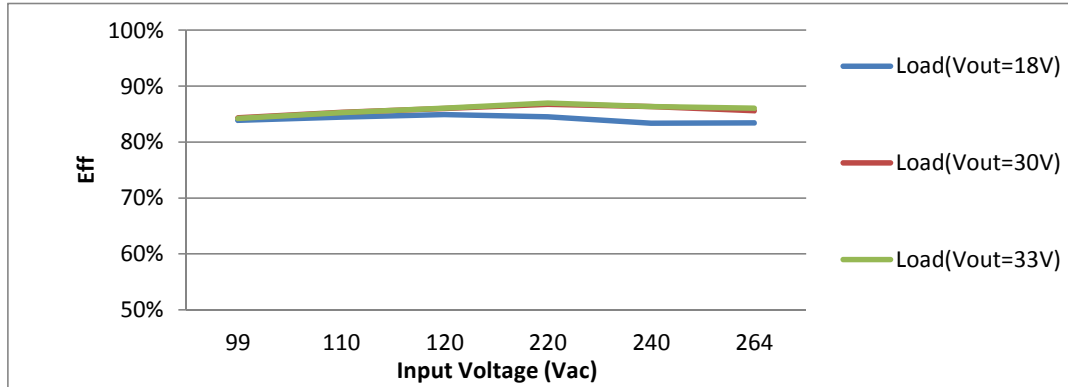

■ Output Current(mA)

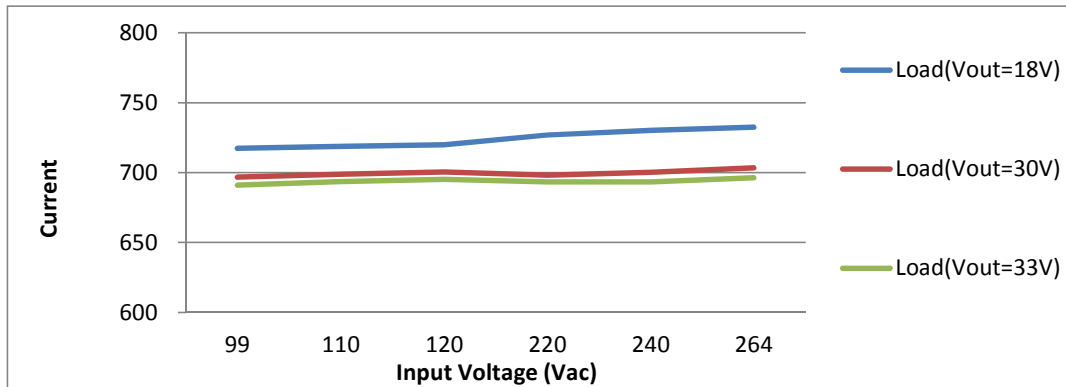

SOLUM Co., Ltd

150, Maeyoung-Ro, Youngtong-Gu, Suwon-Si, Gyeonggi-Do, Republic of Korea 443-743

TEL: +82-1588-0502, www.solu-m.com

■ Mechanical Specification

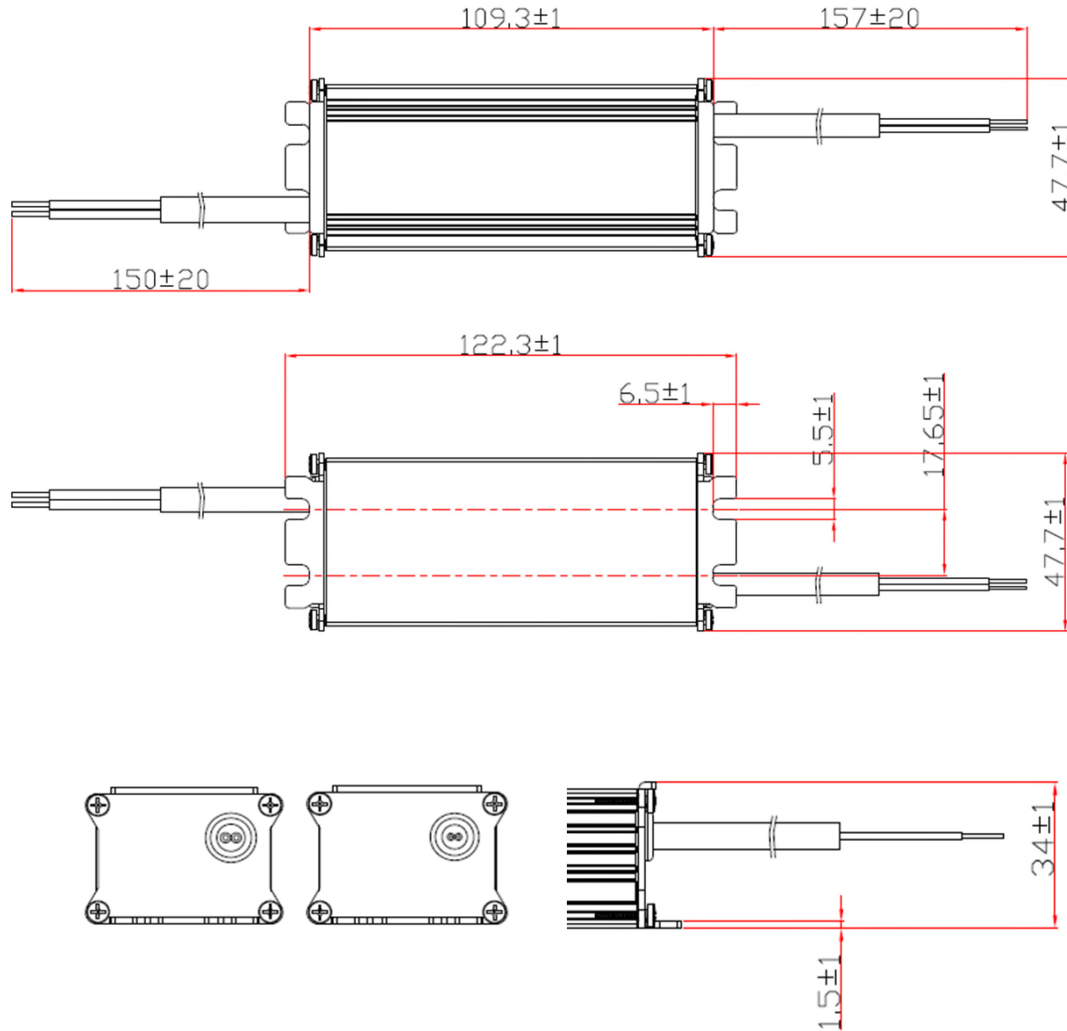

■ Enclosure Size

Unit	Width	Length	Height	Mount Length	Overall Length
mm	47.7	109.3	34.0	122.3	416.3
inch	1.88	4.30	1.34	4.81	16.39

■ Case Material : Aluminium

SOLUM Co., Ltd

150, Maeyoung-Ro, Youngtong-Gu, Suwon-Si, Gyeonggi-Do, Republic of Korea 443-743

TEL: +82-1588-0502, www.solu-m.com

■ Wiring Diagram

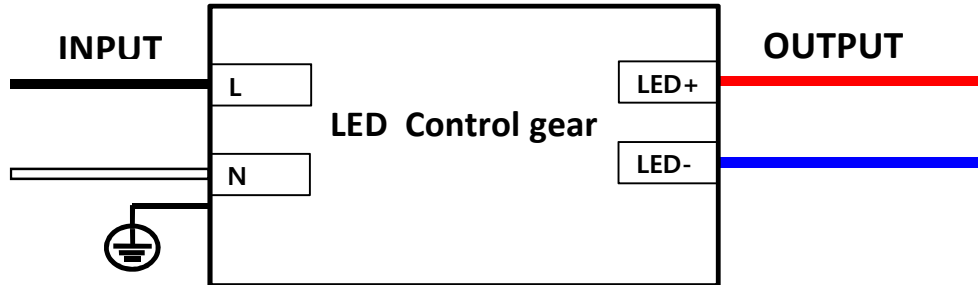

■ Out connector description

Classification	Part No.	Connector (Cable end)	Connector (Opposite side)
Type#1	PSOV250701A	N.A	N.A
Type#2	PSOV250701B	MG610320(KET)	MG610322(KET)
Type#3	PSOV250701C	02R-JWPF-VSLE-S(JST) or 02R-JWPKF-VKLE-S(JST)	02T-JWPF-VSLE-S(JST) or 02T-JWPKF-VKLE-S(JST)

■ Rating Label Drawing

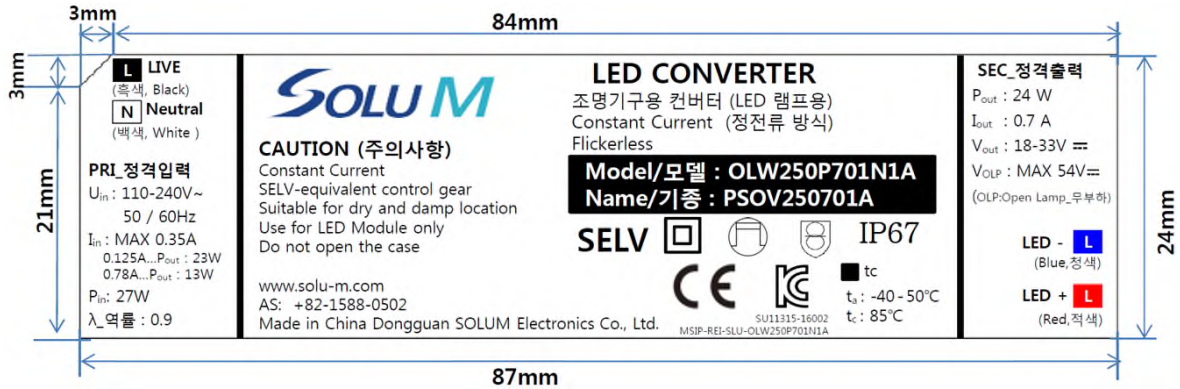

SOLUM Co., Ltd

150, Maeyoung-Ro, Youngtong-Gu, Suwon-Si, Gyeonggi-Do, Republic of Korea 443-743

TEL: +82-1588-0502, www.solu-m.com

Barcode Label

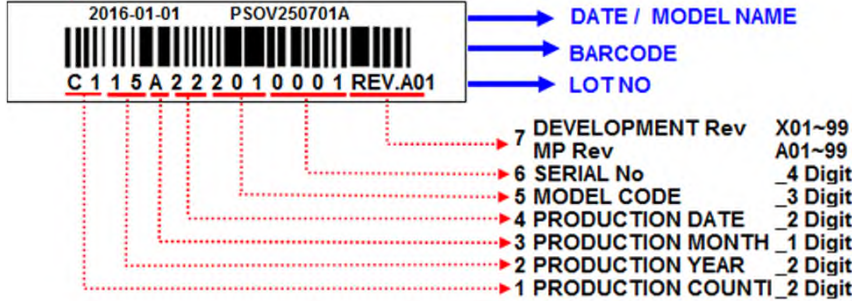

Mean	1.PLANT	2. YEAR	3. MONTH	4. DATE	5. CODE	6. SERIAL	7. Revision No
Digit	2	2	1	2	3	4	
EX.	C1 : DGSM C2 : Solytech C3 : IM C4 : Ap tech K1 : Korea	00~99	1...9,A,B	01~31	201	0001.. 9999	X01~99 : DEVELOPMENT A01~99: MP

Box Label

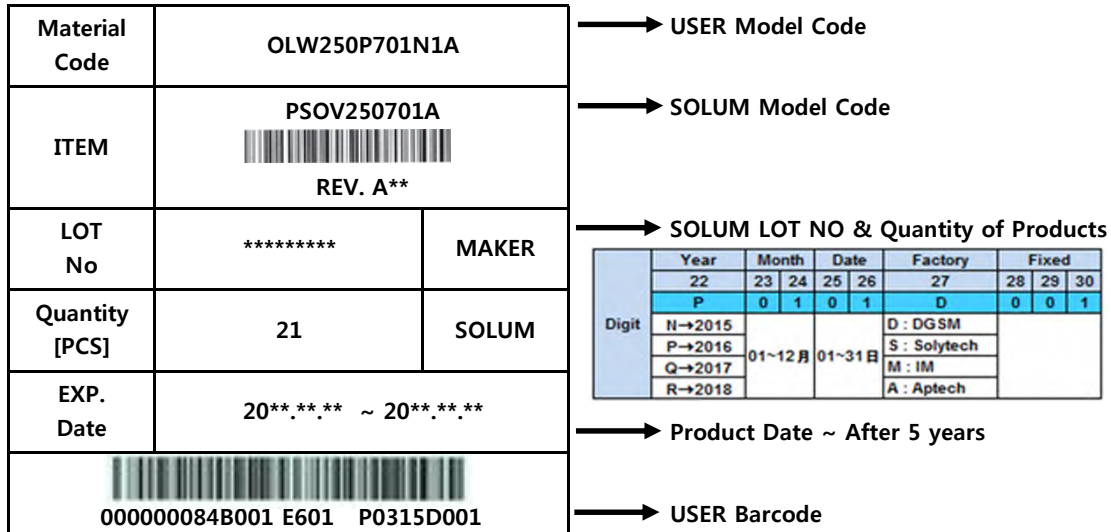

Digit	Quantity Per BOX									BOX Size	Serial No.	Blank	Vender Code	Blank	Year	Month	Date	Factory	Fixed										
	1	2	3	4	5	6	7	8	9	10	11	12	13	14	15	16	17	18	19	20	21	22	23	24	25	26	27	28	29
	0	0	0	0	0	0	0	1	0	B	0	0	1	E	6	0	1				P	0	1	0	1	D	0	0	1
											A : Pallet B : BOX	001~999				N→2015 P→2016 Q→2017 R→2018	01~12月	01~31日	D : DGSM S : Solytech M : IM A : Aptech										

SOLUM Co., Ltd

150, Maeyoung-Ro, Youngtong-Gu, Suwon-Si, Gyeonggi-Do, Republic of Korea 443-743

TEL: +82-1588-0502, www.solu-m.com

■ Packing Drawing

1. Out Box

Dimmension	460(L) 302(W) 100(H) [mm]
Weight	< 7Kg
Quantity	21EA / 1Box

CROSS PAD A

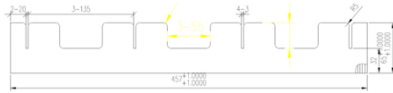

CROSS PAD B

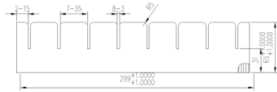

CUSHION PAD

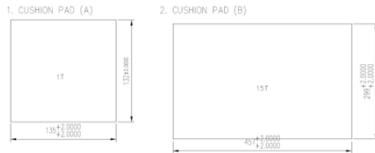

NIL PAD



OUT BOX

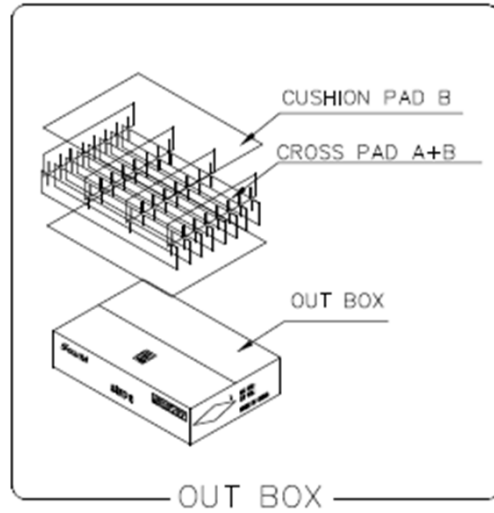
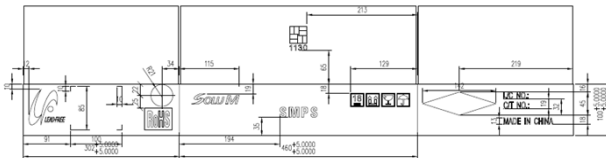

2. Pallet

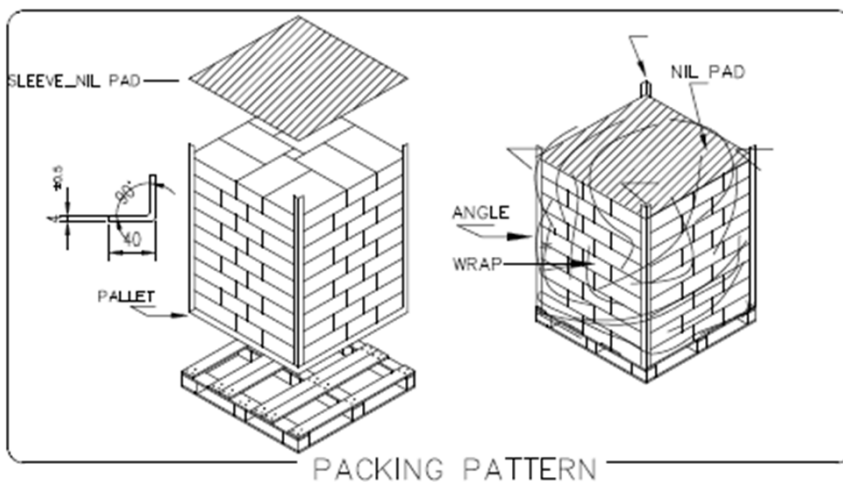

150, Maeyoung-Ro, Youngtong-Gu, Suwon-Si, Gyeonggi-Do, Republic of Korea 443-743

TEL: +82-1588-0502, www.solu-m.com